

## FEATURES

- | High Current Capability
- | Low Forward Voltage Drop
- | Extremely Fast Switching Speed
- | Meet AEC-Q101 Requirements

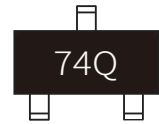

SOT-23



Marking

## MECHANICAL DATA

- | SOT-23 Small Outline Plastic Package
- | Polarity: Color band denotes cathode end
- | Mounting Position: Any

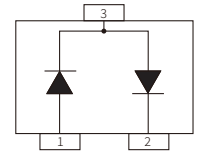

Schematic Symbol

## APPROVALS

<b>RoHS</b>	Compliance with 2011/65/EU
<b>HF</b>	Compliance with IEC61249-2-21:2003

## MAXIMUM RATINGS ( $T_A=25^{\circ}\text{C}$ )

Parameter	Symbol	Value	Unit
Maximum repetitive peak reverse voltage	$V_{RRM}$	70	V
Maximum DC blocking voltage	$V_{DC}$	70	V
Maximum average forward rectified current	$I_{FM}$	70	mA
Typical thermal resistance	$R_{\theta JA}$	430	$^{\circ}\text{C}/\text{W}$
Power Dissipation	$P_D$	200	mW
Junction Temperature	$T_J$	125	$^{\circ}\text{C}$
Storage Temperature Range	$T_{STG}$	-55 to +150	$^{\circ}\text{C}$

## ELECTRICAL CHARACTERISTICS( $T_A=25^{\circ}\text{C}$ )

Parameter	Test Condition	Symbol	Min.	Max.	Unit
Reverse breakdown voltage	$I_R = 10\mu\text{A}$	$V_{(BR)}$	70		V
Maximum reverse current	$V_R = 50\text{V}$	$I_R$		200	nA
Maximum forward voltage	$I_F = 1\text{mA}$	$V_{F1}$		410	mV
	$I_F = 15\text{mA}$	$V_{F2}$		1000	mV
Type junction capacitance	$V_R = 0\text{V}, f = 1\text{MHz}$	$C_D$		2	pF
Reverse Recovery Time	$I_F = I_R = 10\text{mA}$ $I_{rr} = 0.1 \times I_R, R_L = 100\Omega$	$t_{rr}$		5	nS

## CHARACTERISTIC CURVES

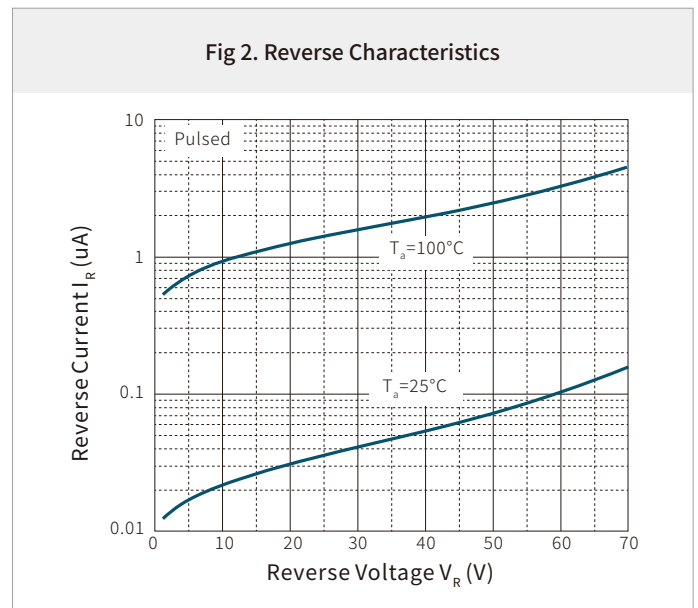
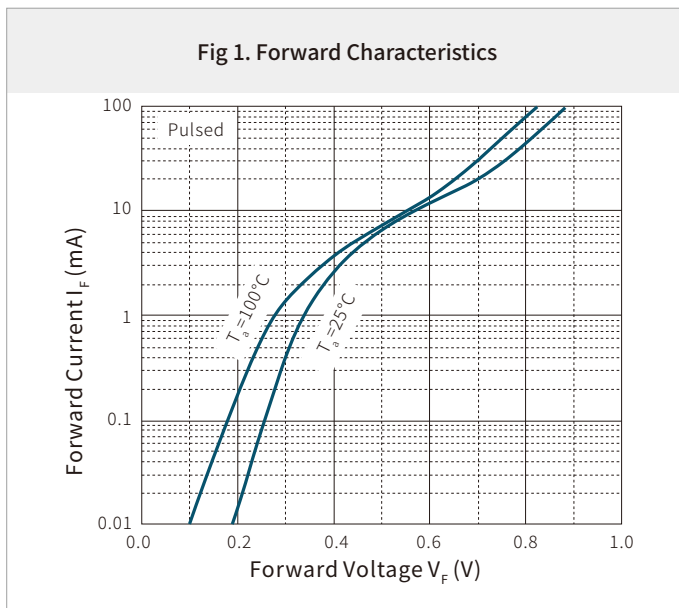

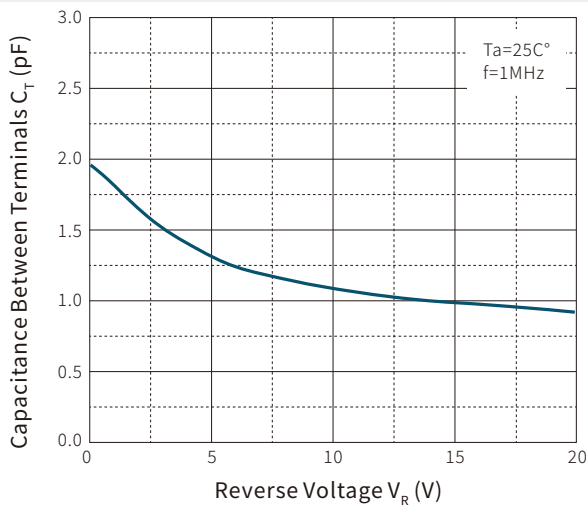
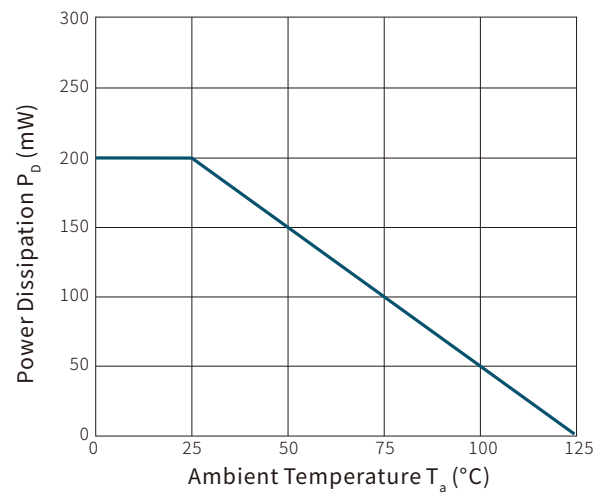
**Fig 3. Capacitance Characteristics**

**Fig 4. Power Derating Curve**

## SOLDERING PARAMETERS

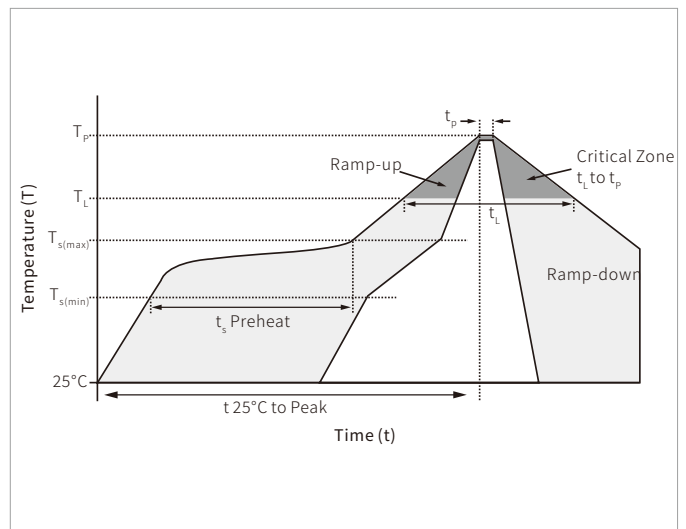
Reflow Condition		Lead-free assembly
Pre Heat	Temperature Max ( $T_{s(min)}$ )	150°C
	Temperature Max ( $T_{s(max)}$ )	200°C
	Time (min to max) ( $t_s$ )	60 – 180 secs
Average ramp up rate (Liquidus Temp ( $T_L$ ) to peak)		3°C/second max
$T_{s(max)}$ to $T_L$ - Ramp-up Rate		3°C/second max
Reflow	Temperature ( $T_L$ ) (Liquidus)	217°C
	Time (min to max) ( $t_L$ )	60 – 150 seconds
Peak Temperature ( $T_p$ )		260°C
Time within 5°C of actual peak Temperature ( $t_p$ )		20 – 40 seconds
Ramp-down Rate		6°C/second max
Time 25°C to peak Temperature ( $T_p$ )		8 minutes max.
Do not exceed		260°C

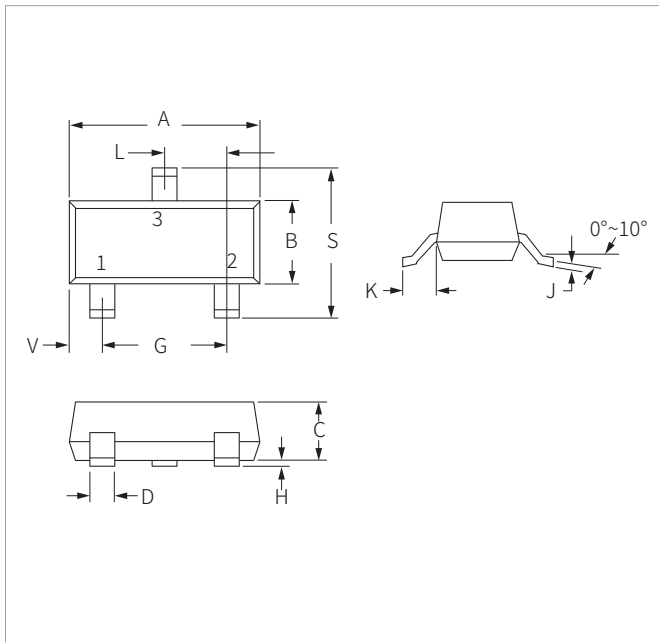

## SOT-23 PACKAGE INFORMATION



Ref.	Millimeters		Inches	
	Min.	Max.	Min.	Max.
A	2.80	3.04	0.110	0.120
B	1.20	1.40	0.047	0.055
C	0.89	1.11	0.035	0.044
D	0.37	0.50	0.015	0.020
G	1.78	2.04	0.070	0.081
H	0.01	0.100	0.001	0.004
J	0.085	0.180	0.003	0.007
K	0.35	0.69	0.014	0.029
L	0.89	1.02	0.035	0.040
S	2.10	2.64	0.083	0.104
V	0.45	0.60	0.018	0.024

## RECOMMENDED PAD LAYOUT DIMENSIONS

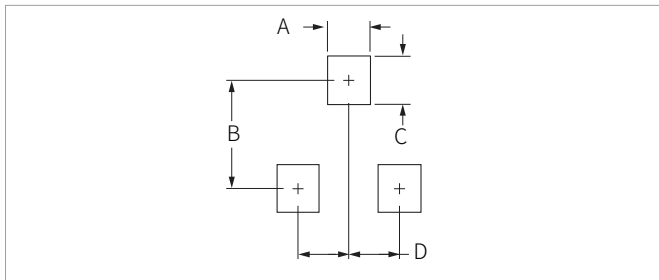

Ref.	Millimeters		Inches	
	Min.	Max.	Min.	Max.
A	0.71	0.97	0.028	0.038
B	1.88	2.13	0.074	0.084
C	0.71	0.97	0.028	0.038
D	0.81	1.07	0.032	0.042

## ORDERING INFORMATION

Part Number	Component Package	QTY/Reel	Reel Size
BAS70-04Q	SOT-23	3000PCS	7"

To find your local partner within Semiwell' s website : [www.semiwell.com.cn](http://www.semiwell.com.cn)

© 2023 Semiwell Microelectronics Co.,Ltd.

The content of this document has been carefully checked and understood. However, neither Semiwell nor its subsidiaries assume any liability whatsoever for any errors or inaccuracies of this document and the consequences thereof. Published specifications are subject to change without notice. Product suitability for any area of application must ultimately be determined by the customer. In all cases, products must never be operated outside their published specifications. Semiwell does not guarantee the availability of all published products. This disclaimer shall be governed by substantive Chinese law and resulting disputes shall be settled by the courts at the place of business of Semiwell. Latest publications and a complete disclaimer can be downloaded from the Semiwell website. All trademarks recognized.