

FEATURES

- | High Current Capability
- | Low Forward Voltage Drop
- | Extremely Fast Switching Speed



SOT-23

MECHANICAL DATA

- | SOT-23 Small Outline Plastic Package
- | Polarity: Color band denotes cathode end
- | Mounting Position: Any

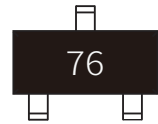

Marking

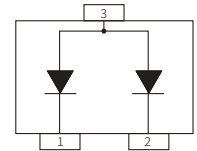

Schematic Symbol

APPROVALS

RoHS	Compliance with 2011/65/EU
HF	Compliance with IEC61249-2-21:2003

MAXIMUM RATINGS ($T_A=25^{\circ}\text{C}$)

Parameter	Symbol	Value	Unit
Maximum repetitive peak reverse voltage	V_{RRM}	70	V
Maximum DC blocking voltage	V_{DC}	70	V
Maximum average forward rectified current	I_{FM}	100	mA
Typical thermal resistance	$R_{\theta JA}$	500	$^{\circ}\text{C}/\text{W}$
Power Dissipation	P_D	200	mW
Junction Temperature	T_J	125	$^{\circ}\text{C}$
Storage Temperature Range	T_{STG}	-55 to +150	$^{\circ}\text{C}$

ELECTRICAL CHARACTERISTICS($T_A=25^{\circ}\text{C}$)

Parameter	Test Condition	Symbol	Min.	Max.	Unit
Reverse breakdown voltage	$I_R = 10\mu\text{A}$	$V_{(BR)}$	70		V
Maximum reverse current	$V_R = 50\text{V}$	I_R		100	nA
Maximum forward voltage	$I_F = 1\text{mA}$	V_{F1}		410	mV
	$I_F = 15\text{mA}$	V_{F2}		1000	mV
Type junction capacitance	$V_R = 0\text{V}, f = 1\text{MHz}$	C_D		2	pF
Reverse Recovery Time	$I_F = I_R = 10\text{mA}$ $I_{rr} = 0.1 \times I_R, R_L = 100\Omega$	t_{rr}		5	nS

CHARACTERISTIC CURVES

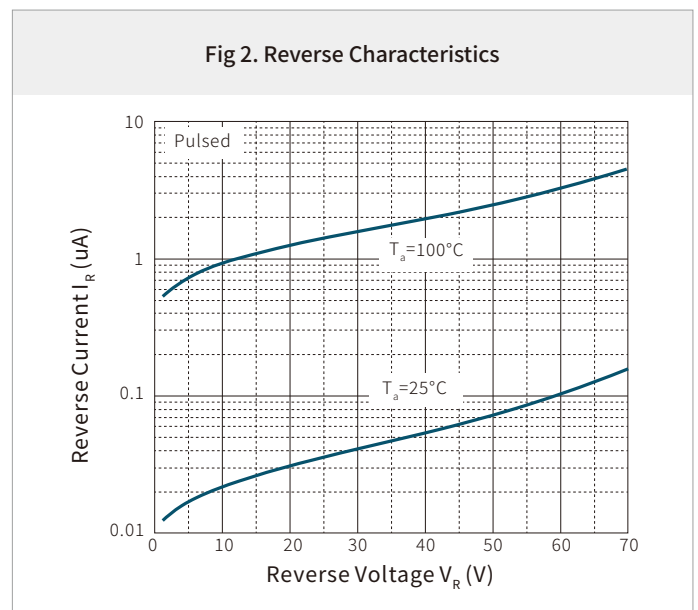
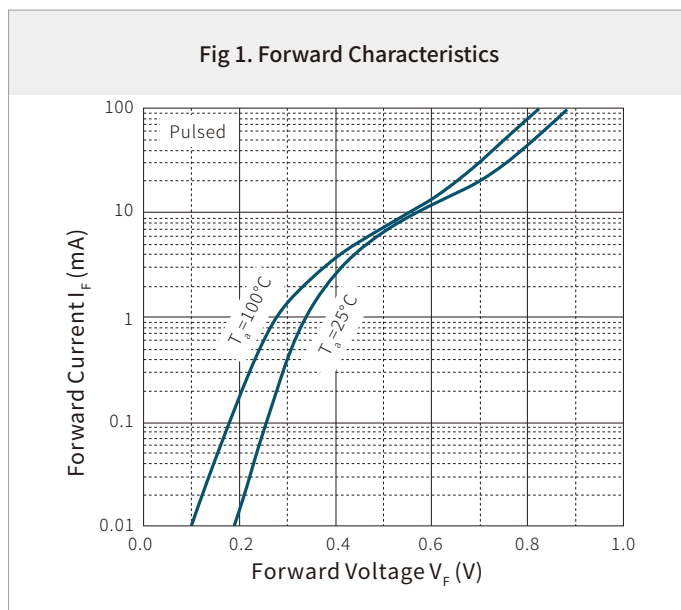
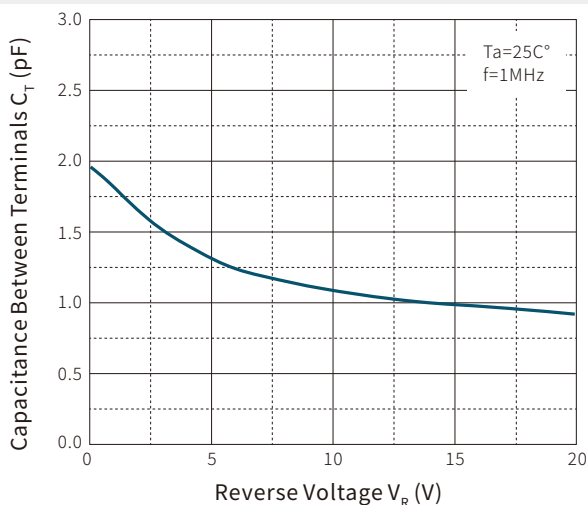
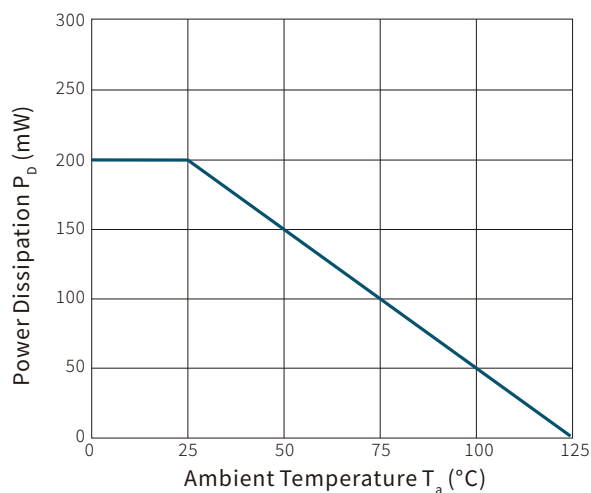
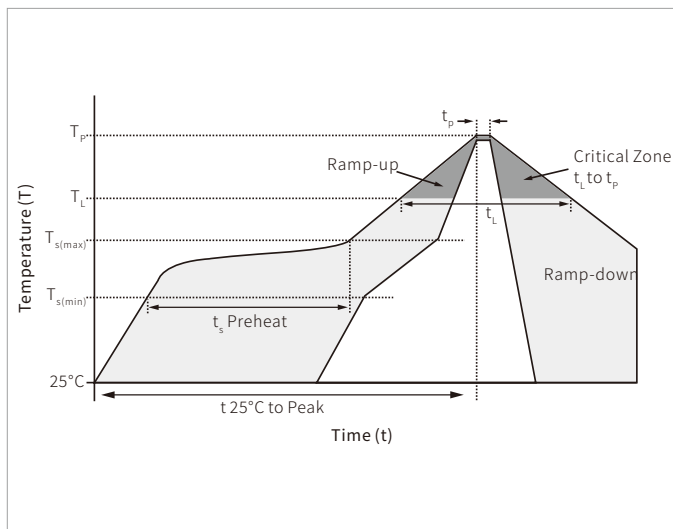

Fig 3. Capacitance Characteristics

Fig 4. Power Derating Curve

SOLDERING PARAMETERS

Reflow Condition		Lead-free assembly
Pre Heat	Temperature Max ($T_{s(min)}$)	150°C
	Temperature Max ($T_{s(max)}$)	200°C
	Time (min to max) (t_s)	60 – 180 secs
Average ramp up rate (Liquidus Temp (T_L) to peak)		3°C/second max
$T_{s(max)}$ to T_L - Ramp-up Rate		3°C/second max
Reflow	Temperature (T_L) (Liquidus)	217°C
	Time (min to max) (t_L)	60 – 150 seconds
Peak Temperature (T_p)		260°C
Time within 5°C of actual peak Temperature (t_p)		20 – 40 seconds
Ramp-down Rate		6°C/second max
Time 25°C to peak Temperature (T_p)		8 minutes max.
Do not exceed		260°C

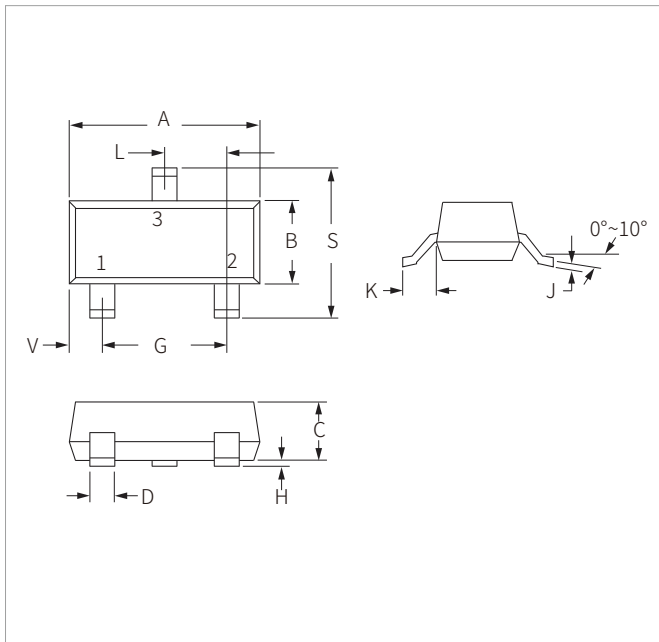

SOT-23 PACKAGE INFORMATION



Ref.	Millimeters		Inches	
	Min.	Max.	Min.	Max.
A	2.80	3.04	0.110	0.120
B	1.20	1.40	0.047	0.055
C	0.89	1.11	0.035	0.044
D	0.37	0.50	0.015	0.020
G	1.78	2.04	0.070	0.081
H	0.01	0.100	0.001	0.004
J	0.085	0.180	0.003	0.007
K	0.35	0.69	0.014	0.029
L	0.89	1.02	0.035	0.040
S	2.10	2.64	0.083	0.104
V	0.45	0.60	0.018	0.024

RECOMMENDED PAD LAYOUT DIMENSIONS

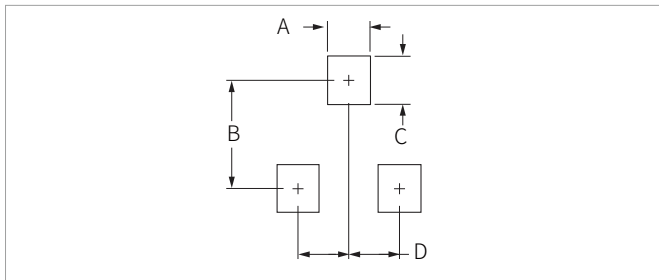

Ref.	Millimeters		Inches	
	Min.	Max.	Min.	Max.
A	0.71	0.97	0.028	0.038
B	1.88	2.13	0.074	0.084
C	0.71	0.97	0.028	0.038
D	0.81	1.07	0.032	0.042

ORDERING INFORMATION

Part Number	Component Package	QTY/Reel	Reel Size
BAS70-06	SOT-23	3000PCS	7"

To find your local partner within Semiwell' s website : www.semiwell.com.cn

© 2023 Semiwell Microelectronics Co.,Ltd.

The content of this document has been carefully checked and understood. However, neither Semiwell nor its subsidiaries assume any liability whatsoever for any errors or inaccuracies of this document and the consequences thereof. Published specifications are subject to change without notice. Product suitability for any area of application must ultimately be determined by the customer. In all cases, products must never be operated outside their published specifications. Semiwell does not guarantee the availability of all published products. This disclaimer shall be governed by substantive Chinese law and resulting disputes shall be settled by the courts at the place of business of Semiwell. Latest publications and a complete disclaimer can be downloaded from the Semiwell website. All trademarks recognized.