

FEATURES

- | High current 100 A RMS current Triac
- | Low thermal resistance
- | High commutation or very high commutation capability

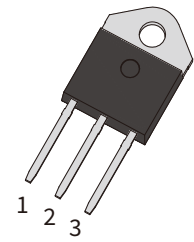

TO-3P

APPLICATIONS

- | General purpose motor control circuits
- | Phase control operations in light dimmers and motor speed controllers
- | Home appliances

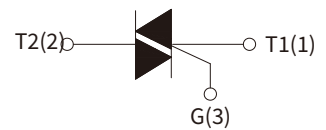

Schematic Symbol

APPROVALS

RoHS	Compliance with 2011/65/EU
HF	Compliance with IEC61249-2-21:2003

THE MAIN PARAMETERS

Symbol	Parameter	Value	Unit
$I_{T(RMS)}$	RMS on-state current	100	A
V_{DRM}	Off-state repetitive peak voltage	800	V
V_{TM}	On-state voltage	1.8	V

ABSOLUTE MAXIMUM RATINGS

Parameter	Symbol	Value	Unit
Repetitive peak off-state voltage ($T_j=25^\circ\text{C}$)	V_{DRM}	800	V
Repetitive peak reverse voltage ($T_j=25^\circ\text{C}$)	V_{RRM}	800	V
RMS on-state current ($T_c=95^\circ\text{C}$)	$I_{\text{T(RMS)}}$	100	A
Non repetitive surge peak on-state current (full cycle , $t_p=20\text{ms}$, $T_j=25^\circ\text{C}$)	I_{TSM}	1100	
Non repetitive surge peak on-state current (full cycle , $t_p=16.6\text{ms}$, $T_j=25^\circ\text{C}$)	I_{TSM}	1210	
I2t value for fusing ($t_p=10\text{ms}$)	I2t	6050	A2S
Critical rate of rise of on-state current ($I_G=2 \cdot I_{GT}$)	di/dt	100	A/ μs
Peak gate current	I_{GM}	10	A
Average gate power dissipation	$P_{\text{G(AV)}}$	0.5	W
Storage junction temperature range	T_{STG}	-40~+150	°C
Operating junction temperature range	T_j	-40~+125	
Peak gate power	P_{GM}	25	W
Peak pulse voltage ($T_j=25^\circ\text{C}$; non-repetitive,off-state;FIG.7)	V_{PP}	1	kV

ELECTRICAL CHARACTERISTICS ($T_j=25^{\circ}\text{C}$ unless otherwise specified)

Symbol	Test Condition	Quadrant	Value	Unit
I_{GT}	$V_D=12V, R_L=33\Omega$	I - II - III	≤ 50	mA
V_{GT}			≤ 1.3	V
V_{GD}	$V_D=V_{DRM}, R_L=3.3K\Omega, T_j=125^{\circ}\text{C}$	I - II - III	≥ 0.2	V
I_H	$I_T=1A$		≤ 100	mA
I_L	$I_G=1.2I_{GT}$	I - III	≤ 180	
		II	≤ 180	
dV_D/dt	$V_D=800V$, Gate Open, $T_j=125^{\circ}\text{C}$		≥ 2000	V/ μs
$(di/dt)_c$	$(dV/dt)_c=20V/\mu\text{s}$ $T_j=125^{\circ}\text{C}$		≥ 25	A/ms
t_{on}	$I_G=100\text{mA}$ $I_A=400\text{mA}$ $I_R=40\text{mA}$ $T_j=25^{\circ}\text{C}$		10	us
t_{off}			70	
V_{TM}	$I_{TM}=150A, t_p=3100\mu\text{s}, T_j=25^{\circ}\text{C}$		≤ 1.8	V
V_{TO}	Threshold voltage, $T_j=125^{\circ}\text{C}$		≤ 0.67	V
R_D	Dynamic resistance, $T_j=125^{\circ}\text{C}$		≤ 7.5	m Ω
I_{DRM}	$V_D=V_{DRM}, V_R=V_{RRM}$	$T_j=25^{\circ}\text{C}$	≤ 15	μA
I_{RRM}		$T_j=125^{\circ}\text{C}$	≤ 12	mA

THERMAL RESISTANCES

Symbol	Parameter	Value	Unit
$R_{th(j-c)}$	Junction to case(AC)	0.26	°C/W

PARAMETER CHARACTERISTIC CURVE

FIG.1 Maximum power dissipation versus RMS on-state current

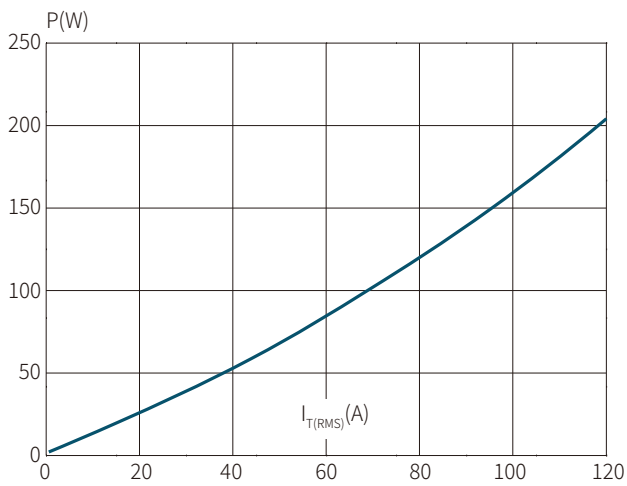

FIG.2: RMS on-state current versus case temperature

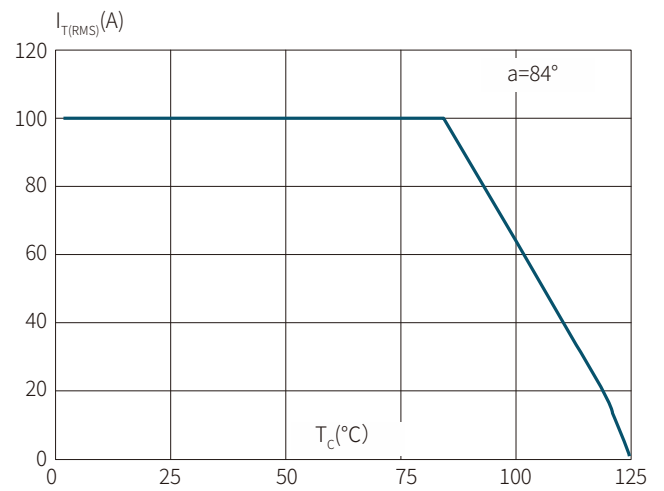

FIG.3: Surge peak on-state current versus number of cycles

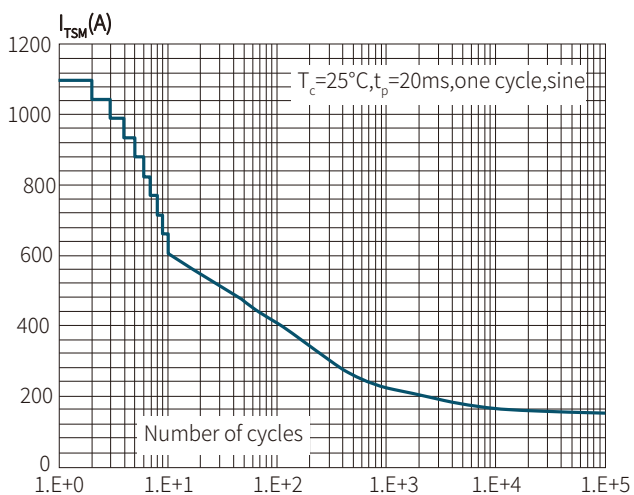

FIG.4 On-state characteristics (maximum values)

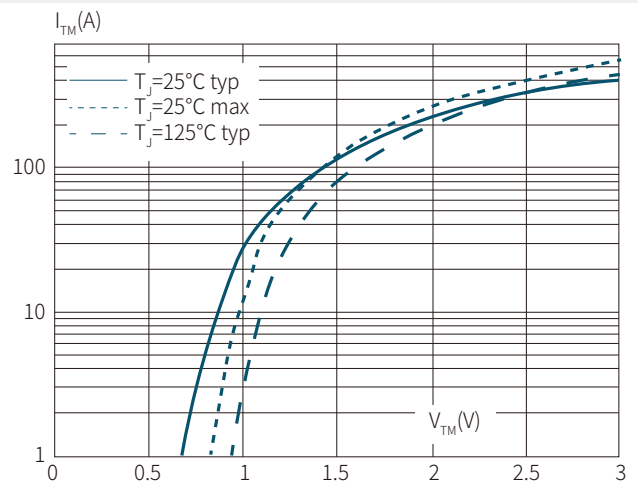

FIG.5: Non-repetitive surge peak on-state current for a sinusoidal pulse with width $t_p < 20\text{ms}$ and corresponding value of I^2t ($dI/dt < 50\text{A}/\mu\text{s}$)

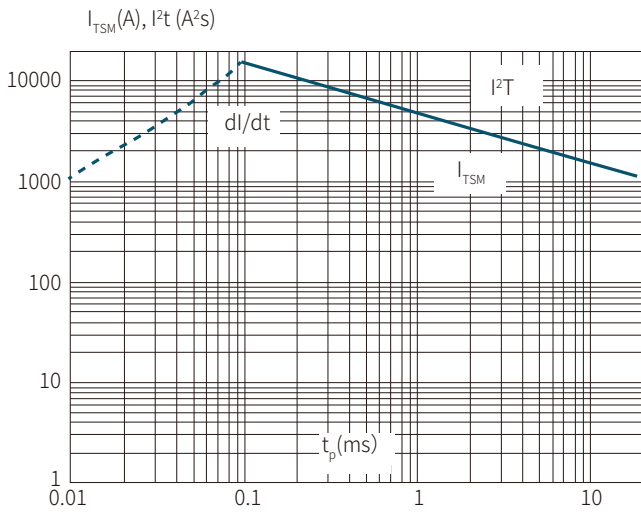

FIG.6 Relative variations of gate trigger current versus junction temperature

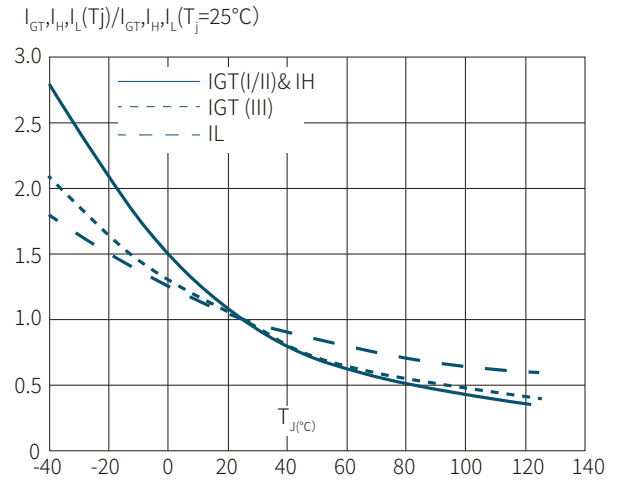
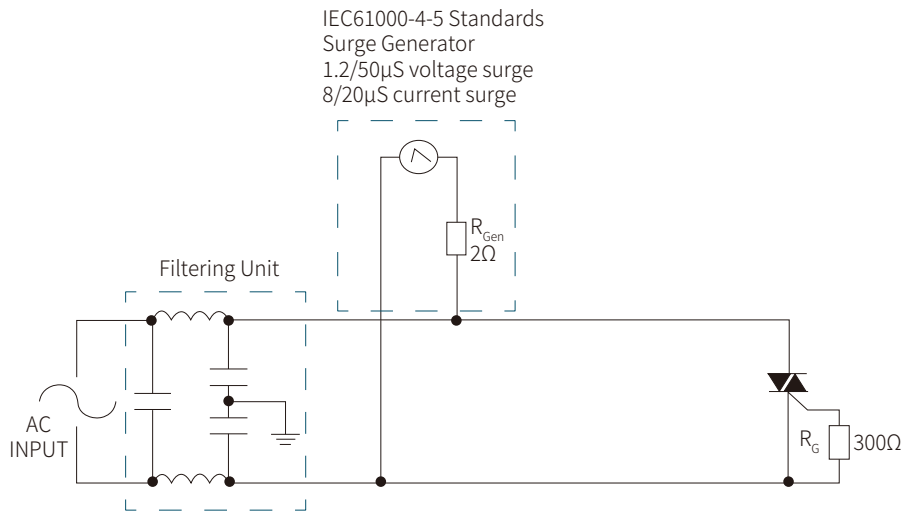
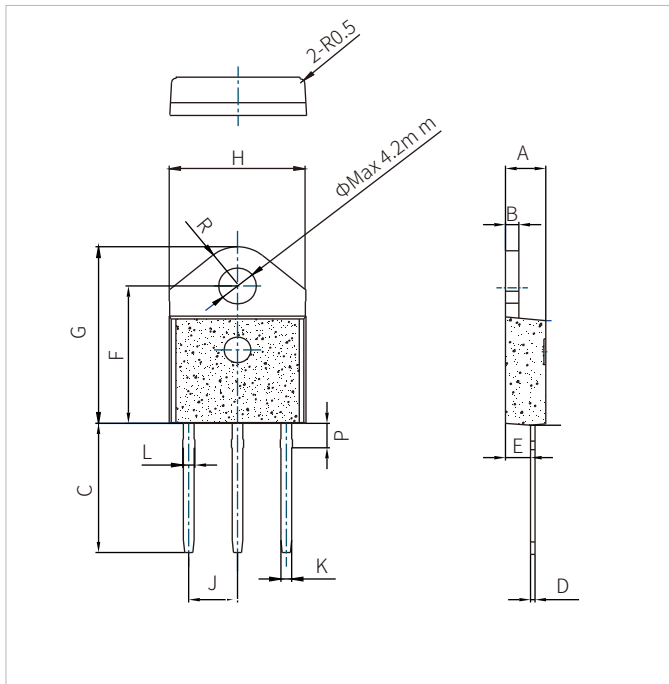

FIG.7: Test circuit for inductive and resistive loads to IEC-61000-4-5 standards



TO-3P PACKAGE MECHANICAL DATA



Ref.	Dimensions					
	Millimeters			Inches		
	Min.	Typ.	Max.	Min.	Typ.	Max.
A	4.40		4.60	0.173		0.181
B	1.45		1.55	0.057		0.061
C	14.35		15.60	0.565		0.614
D	0.50		0.70	0.020		0.028
E	2.70		2.90	0.106		0.114
F	15.80		16.50	0.622		0.650
G	20.40		21.10	0.803		0.831
H	15.10		15.50	0.594		0.610
J	5.40		5.65	0.213		0.222
K	1.10		1.40	0.043		0.055
L	1.35		1.50	0.053		0.059
P	2.80		3.00	0.110		0.118
R		4.35			0.171	

ORDERING INFORMATION

Part Number	Package	Qty/pcs		
		Tube	Inner Box	Carton
BTA100-800BW	TO-3P	30	450	3600

To find your local partner within Semiwell' s website : www.semiwell.com.cn
© 2023 Semiwell Microelectronics Co.,Ltd.

The content of this document has been carefully checked and understood. However, neither Semiwell nor its subsidiaries assume any liability whatsoever for any errors or inaccuracies of this document and the consequences thereof. Published specifications are subject to change without notice. Product suitability for any area of application must ultimately be determined by the customer. In all cases, products must never be operated outside their published specifications. Semiwell does not guarantee the availability of all published products. This disclaimer shall be governed by substantive Chinese law and resulting disputes shall be settled by the courts at the place of business of Semiwell. Latest publications and a complete disclaimer can be downloaded from the Semiwell website. All trademarks recognized.