

## FEATURES

- | High current 24 A RMS current Triac
- | Low thermal resistance
- | High commutation or very high commutation capability
- | Extremely sensitive to trigger
- | UL-94, V0 flammability package resin compliance

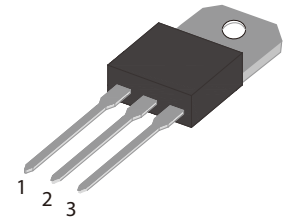

TO-220A

## APPLICATIONS

- | General purpose motor control circuits
- | Phase control operations in light dimmers and motor speed controllers
- | Home appliances

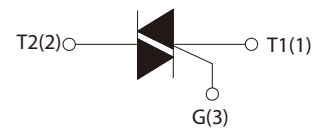

Schematic Symbol

## APPROVALS

<b>RoHS</b>	Compliance with 2011/65/EU
<b>HF</b>	Compliance with IEC61249-2-21:2003

## THE MAIN PARAMETERS

Symbol	Parameter	Value	Unit
$I_{T(RMS)}$	RMS on-state current	24	A
$V_{DRM}$	Off-state repetitive peak voltage	600	V
$V_{TM}$	On-state voltage	1.5	V

## ABSOLUTE MAXIMUM RATINGS

Parameter	Symbol	Value	Unit
Repetitive peak off-state voltage ( $T_j=25^\circ\text{C}$ )	$V_{\text{DRM}}$	600	V
Repetitive peak reverse voltage ( $T_j=25^\circ\text{C}$ )	$V_{\text{RRM}}$	600	V
RMS on-state current ( $T_c=70^\circ\text{C}$ )	$I_{\text{T(RMS)}}$	24	A
Non repetitive surge peak on-state current (full cycle, $F=50\text{Hz}$ )	$I_{\text{TSM}}$	240	
I <sup>2</sup> t value for fusing ( $t_p=10\text{ms}$ )	I <sup>2</sup> t	340	A <sup>2</sup> S
Critical rate of rise of on-state current ( $I_G=2 \cdot I_{\text{GT}}$ )	$d/d_t$	50	A/ $\mu\text{s}$
Peak gate current	$I_{\text{GM}}$	4	A
Average gate power dissipation	$P_{\text{G(AV)}}$	1	W
Storage junction temperature range	$T_{\text{STG}}$	-40~+150	°C
Operating junction temperature range	$T_j$	-40~+125	

## ELECTRICAL CHARACTERISTICS ( $T_j=25^\circ\text{C}$ )

Symbol	Test Condition	Quadrant	Value		Unit
			CW	BW	
$I_{\text{GT}}$	$V_D=12\text{V}, R_L=33\Omega$	I - II - III	$\leq 35$	$\leq 50$	mA
$V_{\text{GT}}$			$\leq 1.5$		
$V_{\text{GD}}$	$V_D=V_{\text{DRM}}, R_L=3.3\text{K}\Omega, T_j=125^\circ\text{C}$		$\geq 0.2$		V
$I_{\text{H}}$	$I_t=100\text{mA}$		$\leq 60$	$\leq 80$	mA
$I_{\text{L}}$	$I_G=1.2I_{\text{GT}}$	I - III	$\leq 70$	$\leq 90$	
		II	$\leq 80$	$\leq 100$	
$dV_D/dt$	$V_D=67\%V_{\text{DRM}}, T_j=125^\circ\text{C}$		$\geq 1000$	$\geq 1500$	V/ $\mu\text{s}$
$V_{\text{TM}}$	$I_{\text{TM}}=35\text{A}, t_p=380\mu\text{s}$		$\leq 1.5$		V
$I_{\text{DRM}}$	$V_D=V_{\text{DRM}}, V_R=V_{\text{RRM}}$	$T_j=25^\circ\text{C}$	$\leq 5$		$\mu\text{A}$
$I_{\text{RRM}}$		$T_j=125^\circ\text{C}$	$\leq 3$		mA

## THERMAL RESISTANCES

Symbol	Parameter	Value	Unit
$R_{th(j-c)}$	Junction to case(AC)	1.5	$^{\circ}\text{C}/\text{W}$

## PARAMETER CHARACTERISTIC CURVE

**FIG.1 Maximum power dissipation versus RMS on-state current**

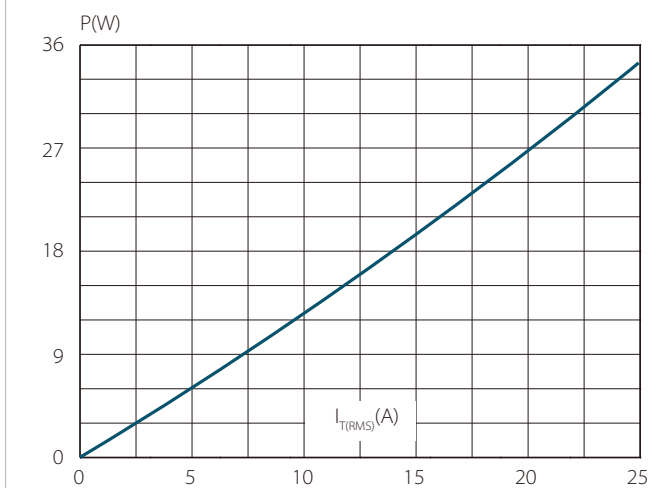

**FIG.2: RMS on-state current versus case temperature**

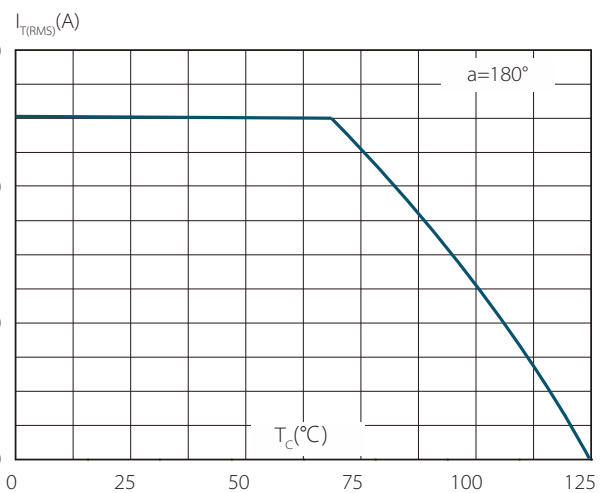

**FIG.3: Surge peak on-state current versus number of cycles**

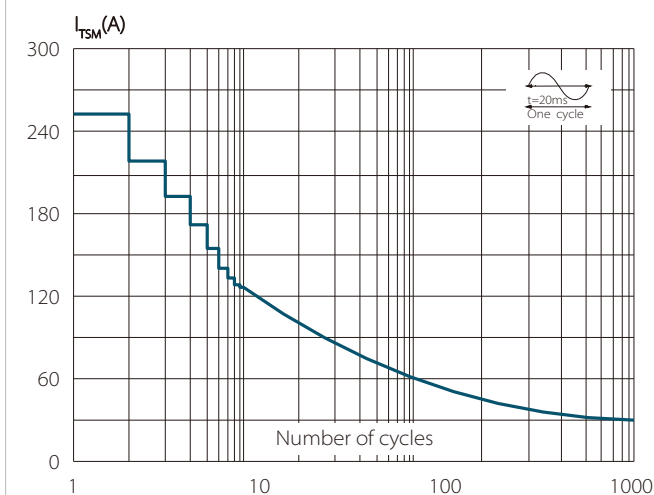

**FIG.4 On-state characteristics (maximum values)**

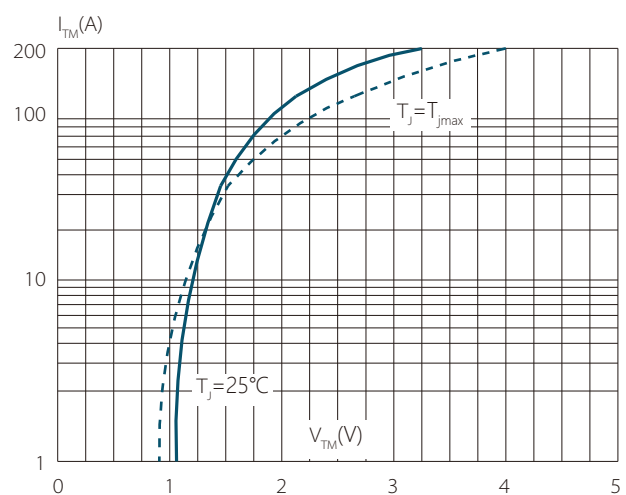

**FIG.5: Non-repetitive surge peak on-state current for a sinusoidal pulse with width  $t_p < 20\text{ms}$  and corresponding value of  $I^2t$  ( $di/dt < 50\text{A}/\mu\text{s}$ )**

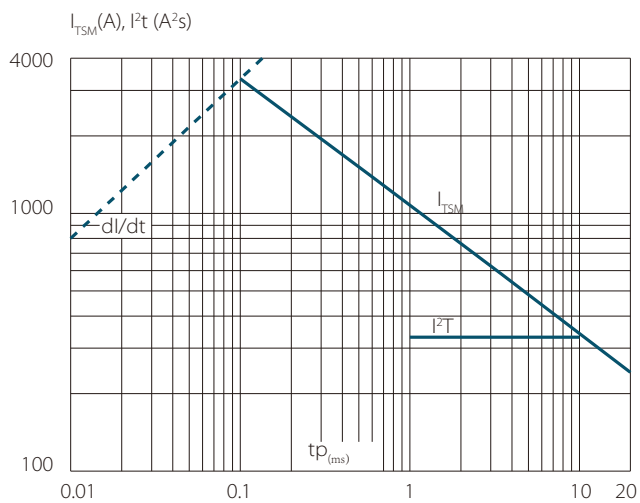

**FIG.6 Relative variations of gate trigger current versus junction temperature**

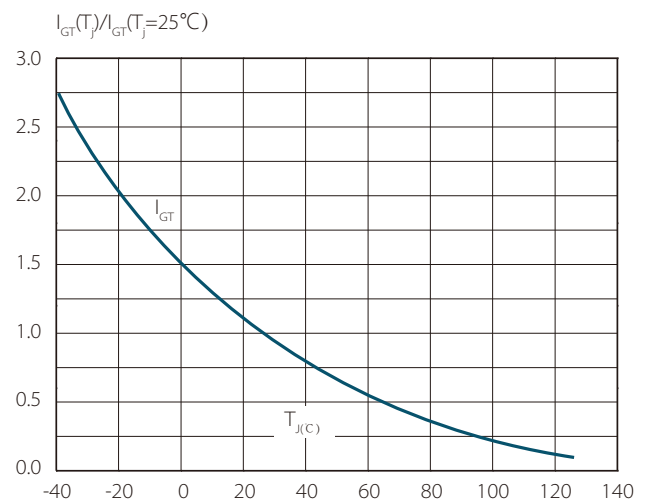

**FIG.7 Relative variations of holding current versus junction temperature**

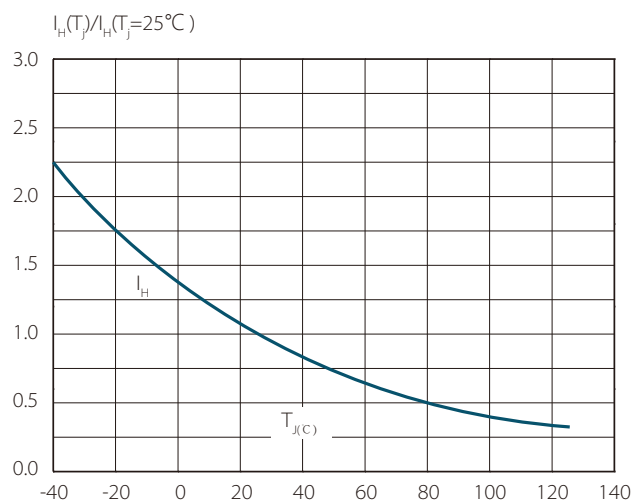

**FIG.8 Relative variations of latching current versus junction temperature**

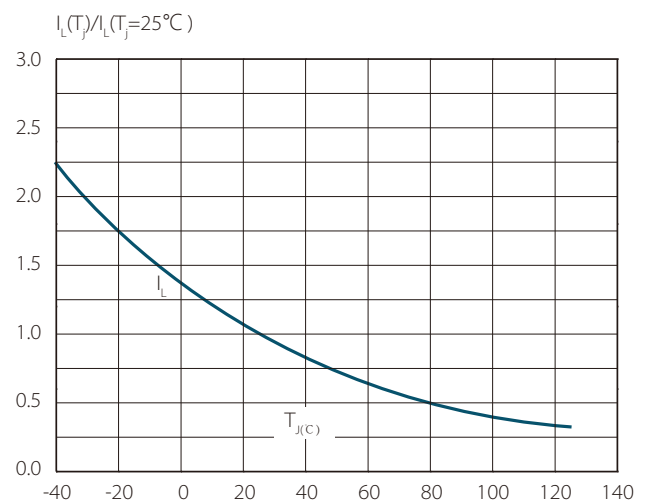

## PACKAGE MECHANICAL DATA

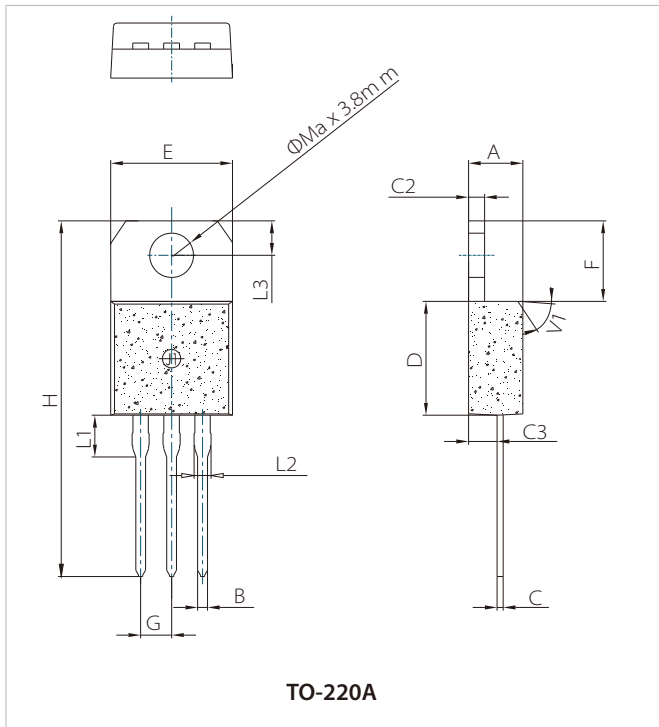

Ref.	Dimensions					
	Millimeters			Inches		
	Min.	Typ.	Max.	Min.	Typ.	Max.
A	4.40		4.60	0.173		0.181
B	0.61		0.88	0.024		0.035
C	0.46		0.70	0.018		0.028
C2	1.21		1.32	0.048		0.052
C3	2.40		2.72	0.094		0.107
D	8.60		9.70	0.339		0.382
E	9.60		10.4	0.378		0.409
F	6.20		6.60	0.222		0.260
G		2.54			0.1	
H	28.0		29.8	1.102		1.173
L1		3.75			0.148	
L2	1.14		1.70	0.045		0.067
L3	2.65		2.95	0.104		0.116
V1		45°			45°	

## ORDERING INFORMATION

Part Number	Package	Marking	Qty/pcs		
			Tube	Inner Box	Carton
BTA24-600CW(BW)	TO-220A	BTA24 600XX	50	1000	5000

To find your local partner within Semiwell' s website : [www.semiwell.com.cn](http://www.semiwell.com.cn)  
© 2023 Semiwell Microelectronics Co.,Ltd.

The content of this document has been carefully checked and understood. However, neither Semiwell nor its subsidiaries assume any liability whatsoever for any errors or inaccuracies of this document and the consequences thereof. Published specifications are subject to change without notice. Product suitability for any area of application must ultimately be determined by the customer. In all cases, products must never be operated outside their published specifications. Semiwell does not guarantee the availability of all published products. This disclaimer shall be governed by substantive Chinese law and resulting disputes shall be settled by the courts at the place of business of Semiwell. Latest publications and a complete disclaimer can be downloaded from the Semiwell website. All trademarks recognized.