

FEATURES

| Complementary to MMBT2907A

| Power Dissipation of 300mW

| High Stability and High Reliability



SOT-23

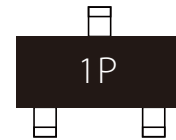

Marking

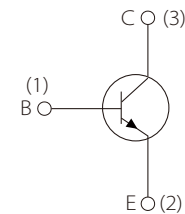

Schematic Symbol

MECHANICAL DATA

| SOT-23 small outline plastic package

| Epoxy UL: 94V-0

| Mounting position: Any

APPROVALS

RoHS	Compliance with 2011/65/EU
HF	Compliance with IEC61249-2-21:2003

MAXIMUM RATINGS ($T_A=25^{\circ}\text{C}$)

Parameter	Symbol	Value	Unit
Collector-Base Voltage	V_{CBO}	75	V
Collector-Emitter Voltage	V_{CEO}	40	
Emitter-Base Voltage	V_{EBO}	6	
Collector Current	I_C	600	mA
Collector Power Dissipation	P_C	300	mW
Thermal Resistance From Junction To Ambient	$R_{\theta JA}$	417	$^{\circ}\text{C}/\text{W}$
Junction Temperature	T_J	150	$^{\circ}\text{C}$
Storage Temperature	T_{STG}	-55~+150	$^{\circ}\text{C}$

ELECTRICAL CHARACTERISTICS (T_A=25°C)

Parameter	Symbol	Test Conditions	Min.	Typ.	Max.	Unit
Collector-base breakdown voltage	V _{(BR)CBO}	I _C =10μA, I _E =0	75			V
Collector-emitter breakdown voltage	V _{(BR)CEO}	I _C =10mA, I _B =0	40			
Emitter-base breakdown voltage	V _{(BR)EBO}	I _E =10μA, I _C =0	6			
Collector cut-off current	I _{CEX}	V _{CE} =30V, V _{EB(off)} =3V			10	nA
Collector cut-off current	I _{CBO}	V _{CB} =60V, I _E =0			10	
Emitter cut-off current	I _{EBO}	V _{EB} =3V, I _C =0			100	
DC current gain	h _{FE(1)}	V _{CE} =10V, I _C =150mA	100		300	
	h _{FE(2)}	V _{CE} =10V, I _C =0.1mA	40			
	h _{FE(3)}	V _{CE} =10V, I _C =500mA	42			
Collector-emitter saturation voltage	V _{CE(sat)1*}	I _C =500mA, I _B =50mA			1.00	V
	V _{CE(sat)2*}	I _C =150mA, I _B =15mA			0.30	
Base-emitter saturation voltage	V _{BE(sat)1*}	I _C =500mA, I _B =50mA			2.00	
	V _{BE(sat)2*}	I _C =150mA, I _B =15mA			1.20	
Transition frequency	f _T	V _{CE} =20V, I _C =20mA, f=100MHz	300			MHz
Delay time	td	V _{CC} =30V, V _{BE(off)} =-0.5V I _C =150mA, I _{B1} =15mA			10	nS
Rise time	tr				25	
Storage time	ts				225	
Fall time	tf		V _{CC} =30V, I _C =150mA, I _{B1} =I _{B2} =15mA			

*Pulse test: pulse width ≤300μs, duty cycle ≤ 2.0%.

CLASSIFICATION OF H_{FE(1)}

Rank	L	H
Range	100-200	200-300

TYPICAL CHARACTERISTICS

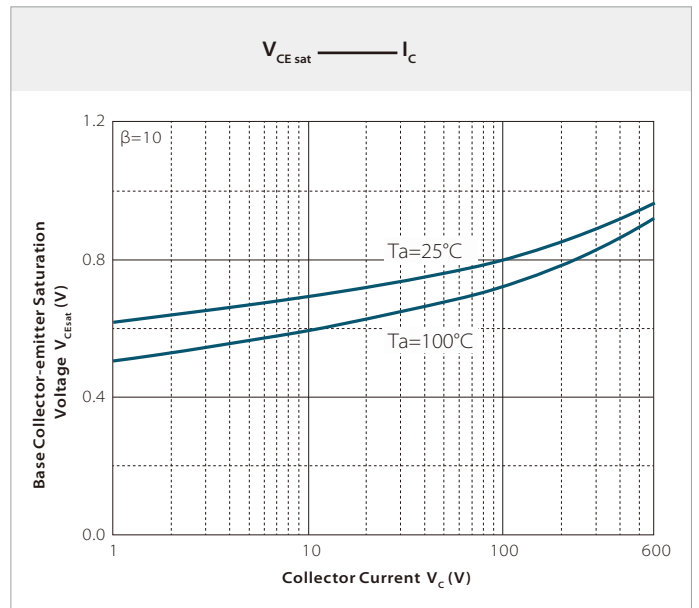
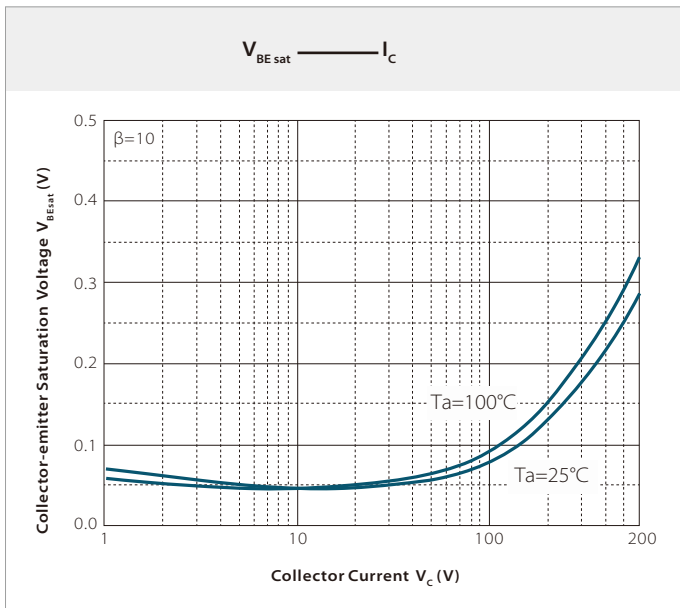
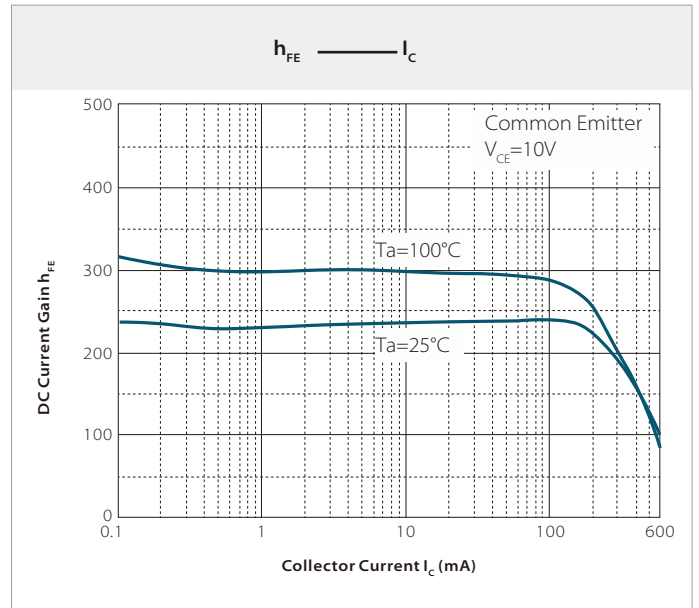
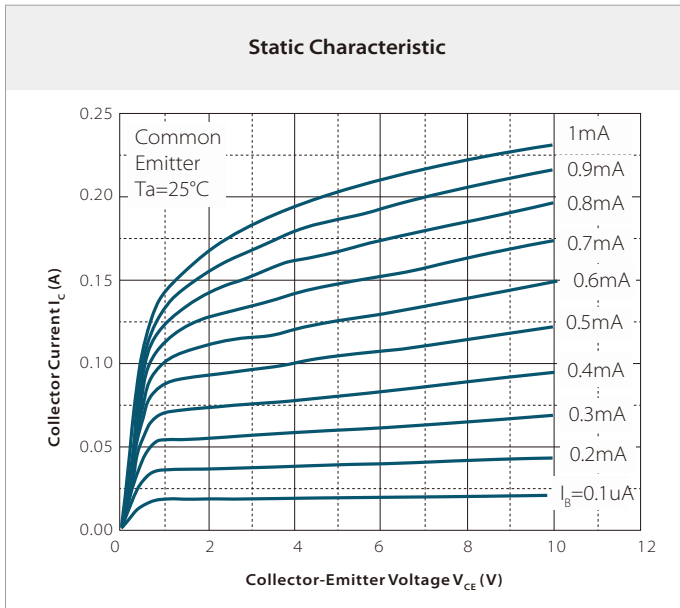

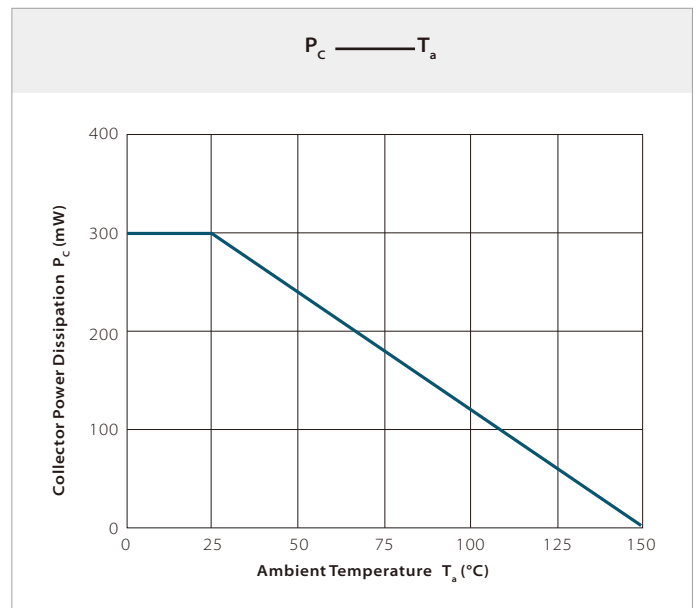
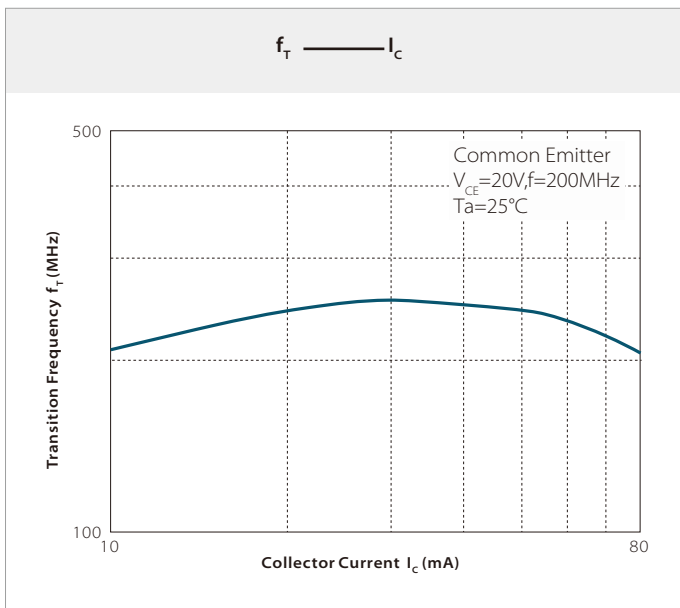
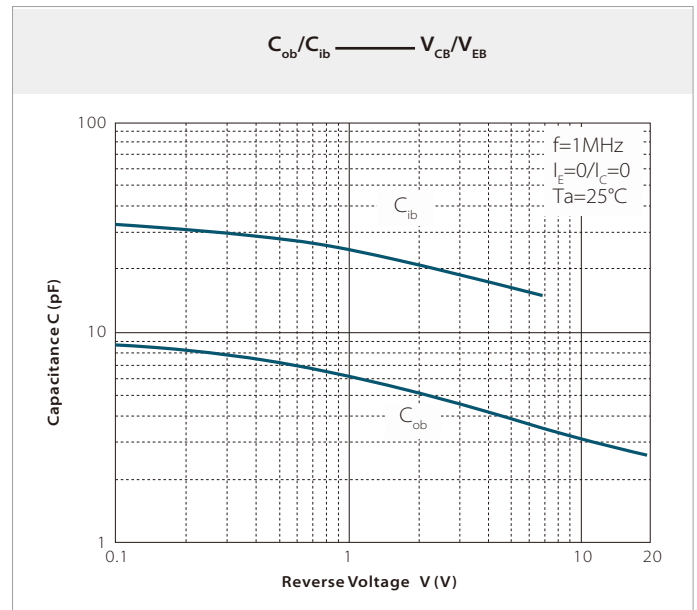
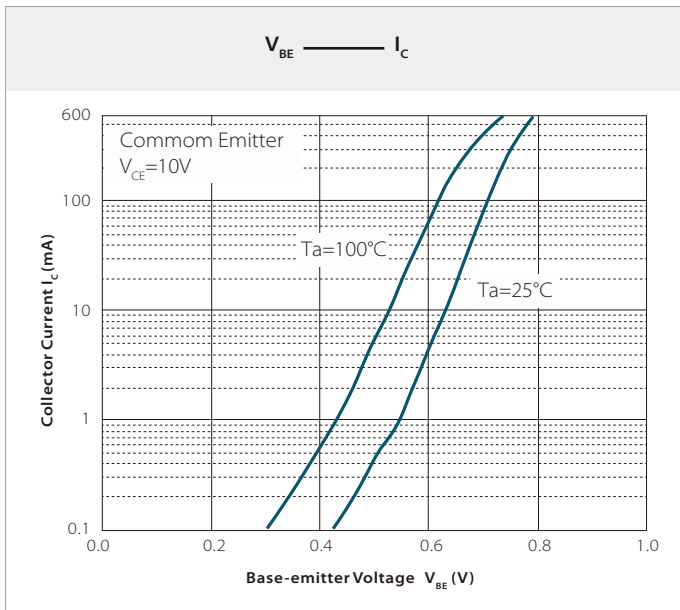

SOT-23 PACKAGE INFORMATION

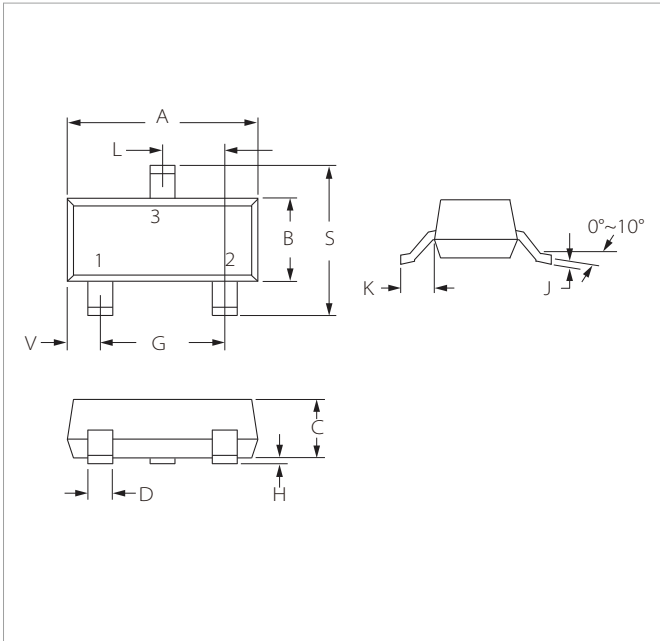

Ref.	Millimeters		Inches	
	Min.	Max.	Min.	Max.
A	2.80	3.04	0.110	0.120
B	1.20	1.40	0.047	0.055
C	0.89	1.11	0.035	0.044
D	0.37	0.50	0.015	0.020
G	1.78	2.04	0.070	0.081
H	0.01	0.100	0.001	0.004
J	0.085	0.180	0.003	0.007
K	0.35	0.69	0.014	0.029
L	0.89	1.02	0.035	0.040
S	2.10	2.64	0.083	0.104
V	0.45	0.60	0.018	0.024

RECOMMENDED PAD LAYOUT DIMENSIONS

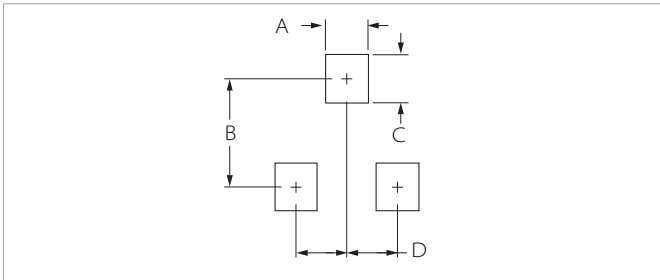

Ref.	Millimeters		Inches	
	Min.	Max.	Min.	Max.
A	0.71	0.97	0.028	0.038
B	1.88	2.13	0.074	0.084
C	0.71	0.97	0.028	0.038
D	0.81	1.07	0.032	0.042

ORDERING INFORMATION

Part Number	Component Package	QTY/Reel	Reel Size
MMBT2222A	SOT-23	3000PCS	7"

To find your local partner within Semiwell's website : www.semiwell.com.cn

©2023 Semiwell Microelectronics Co.,Ltd.

The content of this document has been carefully checked and understood. However, neither Semiwell nor its subsidiaries assume any liability whatsoever for any errors or inaccuracies of this document and the consequences thereof. Published specifications are subject to change without notice. Product suitability for any area of application must ultimately be determined by the customer. In all cases, products must never be operated outside their published specifications. Semiwell does not guarantee the availability of all published products. This disclaimer shall be governed by substantive Chinese law and resulting disputes shall be settled by the courts at the place of business of Semiwell. Latest publications and a complete disclaimer can be downloaded from the Semiwell website. All trademarks recognized.