

FEATURES

- | Complementary to MMBT5551
- | Ideal for medium power amplification and switching



SOT-23

MECHANICAL DATA

- | SOT-23 small outline plastic package
- | Epoxy UL: 94V-0
- | Mounting position: Any

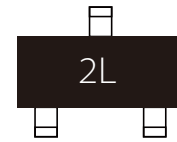

Marking

APPROVALS

RoHS	Compliance with 2011/65/EU
HF	Compliance with IEC61249-2-21:2003

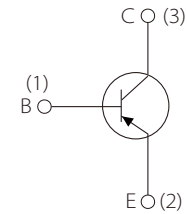

Schematic Symbol

MAXIMUM RATINGS (T_A=25°C)

Parameter	Symbol	Value	Unit
Collector-Base Voltage	V _{CBO}	-160	V
Collector-Emitter Voltage	V _{CEO}	-150	
Emitter-Base Voltage	V _{EBO}	-5	
Collector Current -Continuous	I _C	-0.6	A
Collector Power Dissipation	P _C	0.3	W
Junction Temperature	T _J	150	°C
Storage Temperature	T _{STG}	-55~+150	°C

ELECTRICAL CHARACTERISTICS (T_A=25°C)

Parameter	Symbol	Test Conditions	Min.	Typ.	Max.	Unit
Collector-base breakdown voltage	V _{(BR)CBO}	I _C =-100μA, I _E =0	-160			V
Collector-emitter breakdown voltage	V _{(BR)CEO}	I _C =-1mA, I _B =0	-150			
Emitter-base breakdown voltage	V _{(BR)EBO}	I _E =-10μA, I _C =0	-5			
Collector cut-off current	I _{CBO}	V _{CB} = -120V, I _E =0			-0.1	μA
Emitter cut-off current	I _{EBO}	V _{EB} =-4V, I _C =0			-0.1	
DC current gain	h _{FE(1)}	V _{CE} =-5V, I _C =-1mA	80			
	h _{FE(2)}	V _{CE} =-5V, I _C =-10mA	100		300	
	h _{FE(3)}	V _{CE} =-5V, I _C =-50mA	50			
Collector-emitter saturation voltage	V _{CE(sat)}	I _C =-50mA, I _B =-5mA			-0.5	V
Base-emitter saturation voltage	V _{BE(sat)}	I _C =-50mA, I _B =-5mA			-1	
Transition frequency	f _T	V _{CE} =-5V, I _C =-10mA	100			MHz

TYPICAL CHARACTERISTICS

Max Power Dissipation vs Ambient Temperature

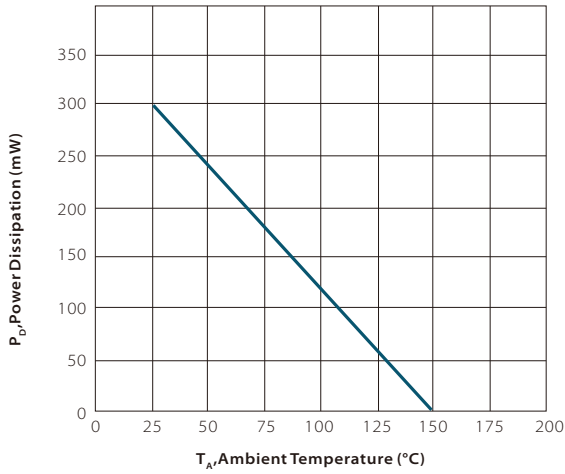

Collector Emitter Saturation Voltage vs. Collector Current

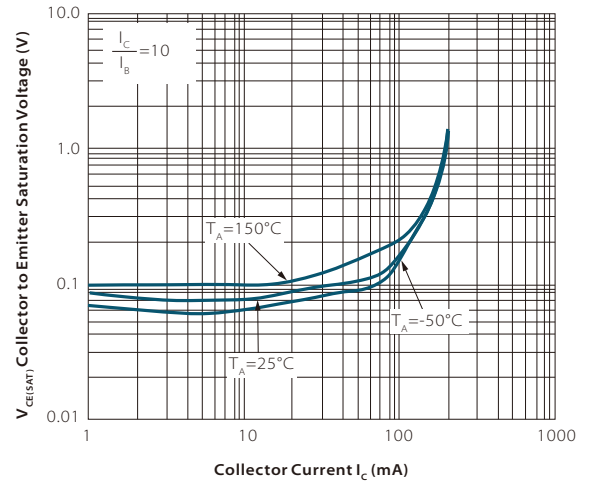

DC Current Gain vs. Collector Current

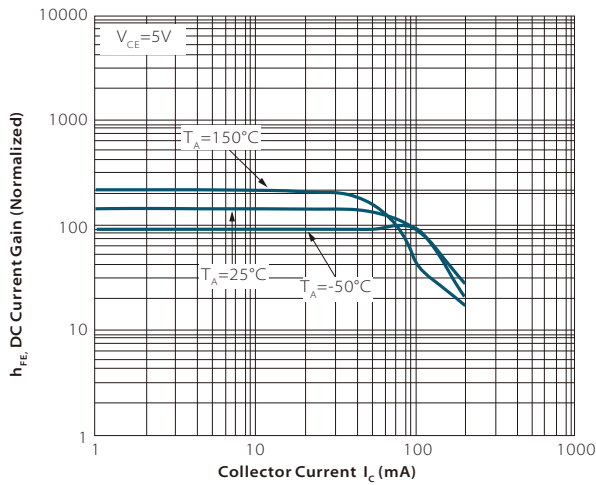

Base Emitter vs. Collector Current

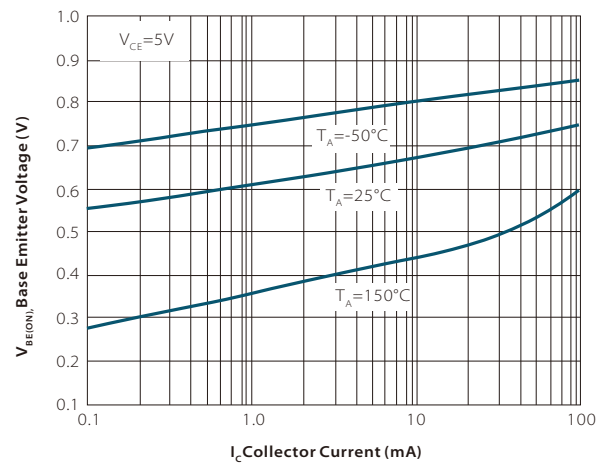

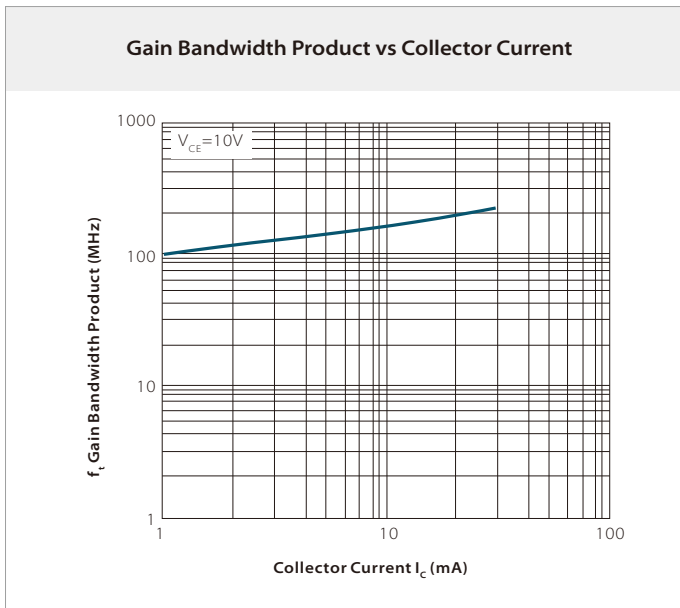

SOLDERING PARAMETERS

Reflow Condition		Lead-free assembly
Pre Heat	Temperature Max ($T_{s(min)}$)	150°C
	Temperature Max ($T_{s(max)}$)	200°C
	Time (min to max) (t_s)	60 – 180 secs
Average ramp up rate (Liquidus Temp (T_L) to peak)		3°C/second max
$T_{s(max)}$ to T_L - Ramp-up Rate		3°C/second max
Reflow	Temperature (T_L) (Liquidus)	217°C
	Time (min to max) (t_L)	60 – 150 seconds
Peak Temperature (T_p)		260°C
Time within 5°C of actual peak Temperature (t_p)		20 – 40 seconds
Ramp-down Rate		6°C/second max
Time 25°C to peak Temperature (T_p)		8 minutes max.
Do not exceed		260°C

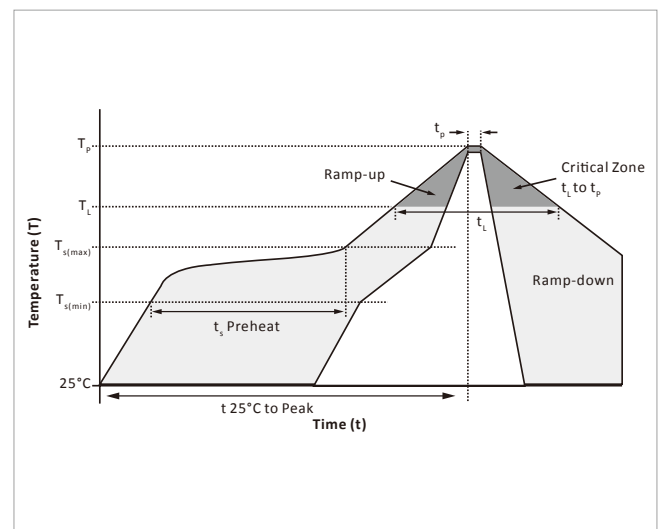

SOT-23 PACKAGE INFORMATION

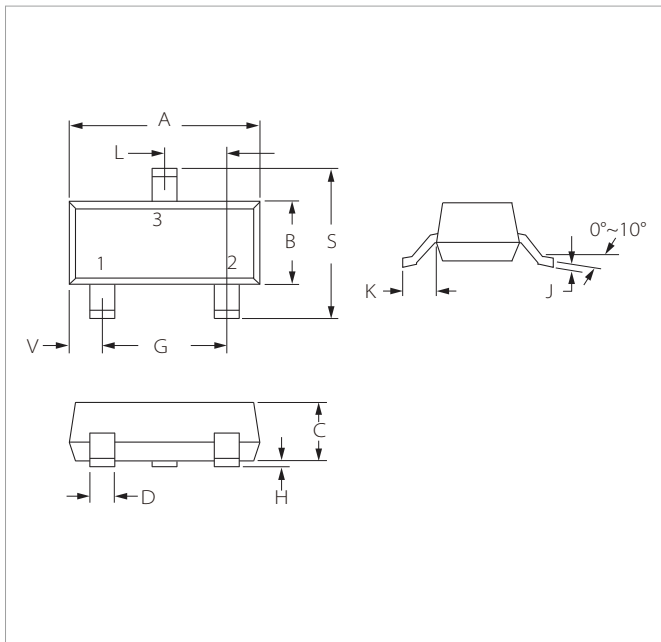

Ref.	Millimeters		Inches	
	Min.	Max.	Min.	Max.
A	2.80	3.04	0.110	0.120
B	1.20	1.40	0.047	0.055
C	0.89	1.11	0.035	0.044
D	0.37	0.50	0.015	0.020
G	1.78	2.04	0.070	0.081
H	0.01	0.100	0.001	0.004
J	0.085	0.180	0.003	0.007
K	0.35	0.69	0.014	0.029
L	0.89	1.02	0.035	0.040
S	2.10	2.64	0.083	0.104
V	0.45	0.60	0.018	0.024

RECOMMENDED PAD LAYOUT DIMENSIONS

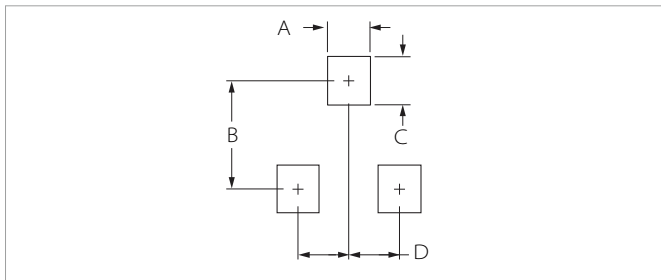

Ref.	Millimeters		Inches	
	Min.	Max.	Min.	Max.
A	0.71	0.97	0.028	0.038
B	1.88	2.13	0.074	0.084
C	0.71	0.97	0.028	0.038
D	0.81	1.07	0.032	0.042

ORDERING INFORMATION

Part Number	Component Package	QTY/Reel	Reel Size
MMBT5401	SOT-23	3000PCS	7"

To find your local partner within Semiwell's website : www.semiwell.com.cn

©2023 Semiwell Microelectronics Co.,Ltd.

The content of this document has been carefully checked and understood. However, neither Semiwell nor its subsidiaries assume any liability whatsoever for any errors or inaccuracies of this document and the consequences thereof. Published specifications are subject to change without notice. Product suitability for any area of application must ultimately be determined by the customer. In all cases, products must never be operated outside their published specifications. Semiwell does not guarantee the availability of all published products. This disclaimer shall be governed by substantive Chinese law and resulting disputes shall be settled by the courts at the place of business of Semiwell. Latest publications and a complete disclaimer can be downloaded from the Semiwell website. All trademarks recognized.