

FEATURES

- | 100W Peak Pulse Power per Line (tp=8/20μs)
- | Protects four I/O lines
- | Operating voltage: 5 V
- | Low capacitance: 0.8pF typical (I/O to GND)
- | Weight:8.0mg

APPLICATIONS

- | High Definition Multi-Media Interface (HDMI)
- | Digital Visual Interface (DVI)
- | MDDI Ports
- | PCI Express
- | Serial ATA
- | 10/100/1000 Ethernet

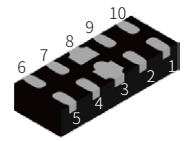

DFN2510P10

P524

Marking

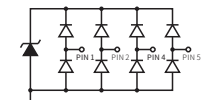

Schematic Symbol

IEC COMPATIBILITY

- | IEC61000-4-2 (ESD) ±30kV (air), ±30kV (contact)
- | IEC61000-4-4 (EFT) 40A (5/50ns)

APPROVALS

- RoHS** Compliance with 2011/65/EU
- HF** Compliance with IEC61249-2-21:2003

THERMAL CONSIDERATIONS

Symbol	Parameter	Value	Unit
P_{PP}	Peak Pulse Power (tp=8/20μs waveform)	100	Watts
T_J	Operating Temperature Range	-55 to +150	°C
T_{STG}	Storage Temperature Range	-55 to +150	°C

ELECTRICAL CHARACTERISTICS

Symbol	Parameter	Condition	Min.	Typ.	Max.	Unit
V_{RWM}	Reverse Stand-off Voltage				5	V
V_{BR}	Reverse Breakdown Voltage	$I_T=1mA$	6			V
I_R	Reverse Leakage Current	$V_{RWM}=5V$			1	μA
V_C	Clamping Voltage	$I_{PP}=1A, tp=8/20us$			12	V
V_C	Clamping Voltage	$I_{PP}=5A, tp=8/20us$			16	V
I_{PP}	Peak Pulse Current	tp=8/20us			5	A
C_J	Off State Junction Capacitance	$V_R=0V, f=1MHz$ I/O-I/O		0.3		pF
C_J	Off State Junction Capacitance	$V_R=0V, f=1MHz$ I/O-GND		0.6		pF

CHARACTERISTIC CURVES

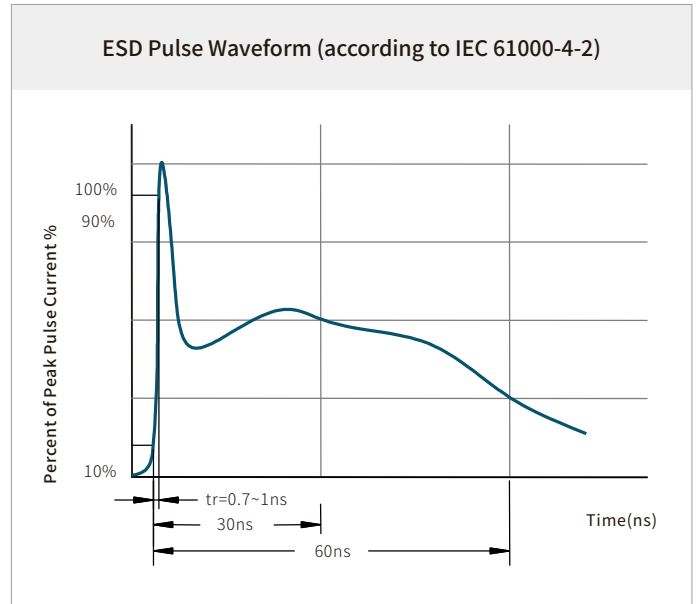
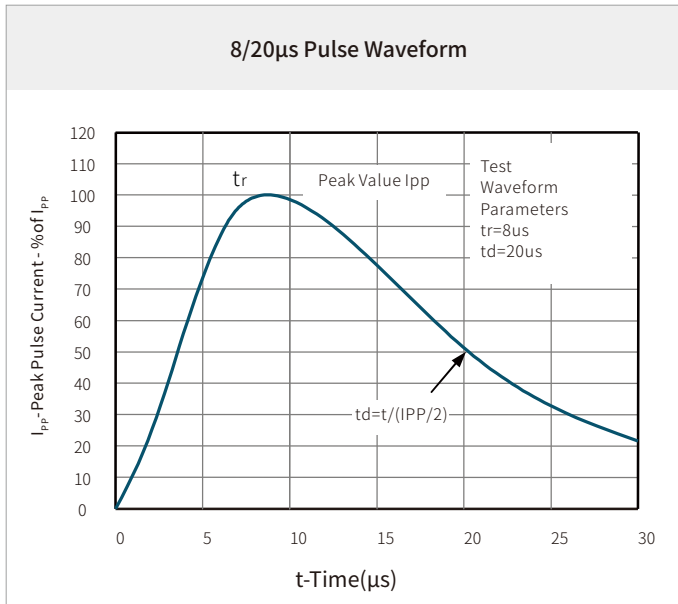

SOLDERING PARAMETERS

Reflow Condition		Lead-free assembly
Pre Heat	Temperature Max ($T_{s(min)}$)	150°C
	Temperature Max ($T_{s(max)}$)	200°C
	Time (min to max) (t_s)	60 – 180 secs
Average ramp up rate (Liquidus Temp (T_L) to peak)		3°C/second max
$T_{s(max)}$ to T_L - Ramp-up Rate		3°C/second max
Reflow	Temperature (T_L) (Liquidus)	217°C
	Time (min to max) (t_L)	60 – 150 seconds
Peak Temperature (T_p)		260°C
Time within 5°C of actual peak Temperature (t_p)		20 – 40 seconds
Ramp-down Rate		6°C/second max
Time 25°C to peak Temperature (T_p)		8 minutes max.
Do not exceed		260°C

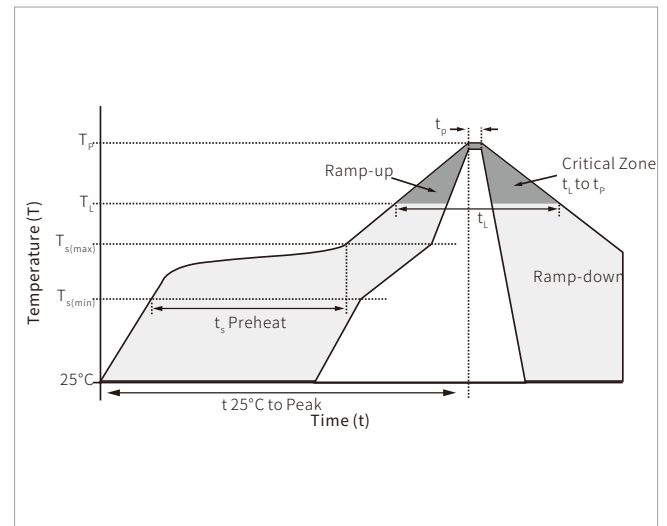

DFN2510P10 PACKAGE INFORMATION

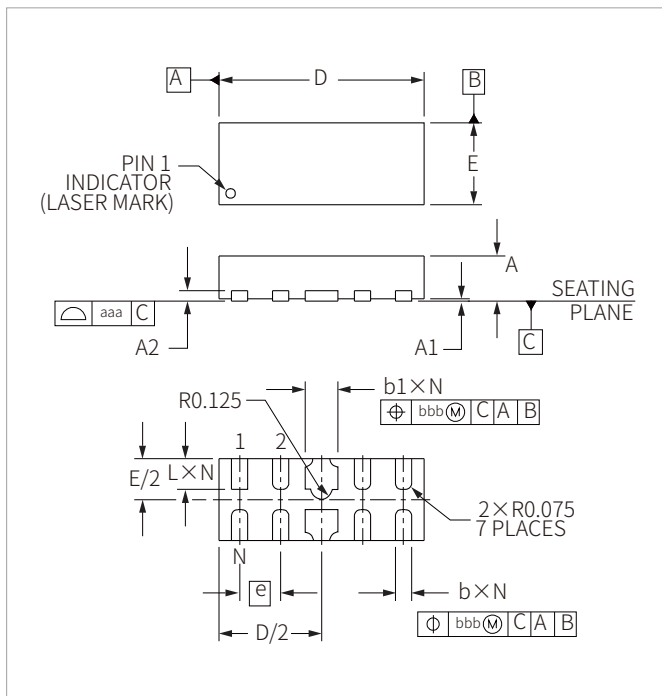

Ref.	Millimeters		Inches	
	Min.	Max.	Min.	Max.
A	0.40	0.65	0.016	0.026
A1	0	0.05	0	0.002
A2	(0.13)		(0.005)	
b	0.15	0.25	0.006	0.010
b1	0.35	0.45	0.014	0.018
D	2.40	2.60	0.094	0.102
E	0.90	1.10	0.035	0.043
e	0.50BSC		0.020BSC	
L	0.30	0.45	0.012	0.018
N	8		8	
aaa	0.08		0.003	
bbb	0.10		0.004	

RECOMMENDED PAD LAYOUT DIMENSIONS

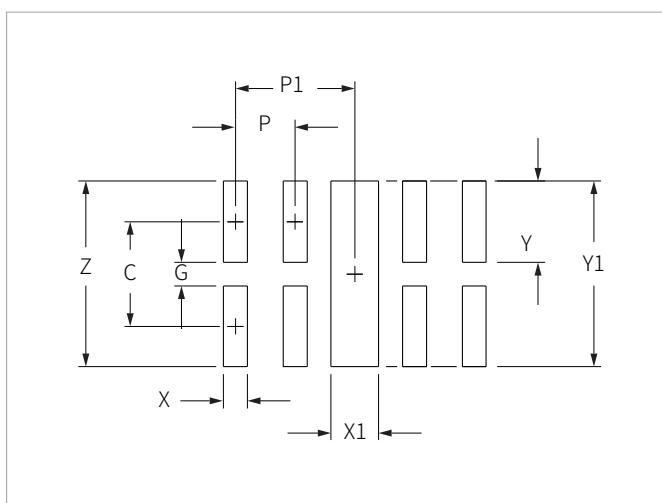

Ref.	Millimeters	Inches
C	0.87	0.034
G	0.20	0.008
P	0.50	0.020
P1	1.00	0.039
X	0.20	0.008
X1	0.40	0.016
Y	0.68	0.027
Y1	1.55	0.061
Z	1.55	0.061

ORDERING INFORMATION

Part Number	Component Package	QTY/Reel	Reel Size
RCLAMP0524P	DFN2510P10	3000PCS	7"

To find your local partner within Semiwell' s website : www.semiwell.com.cn

© 2023 Semiwell Microelectronics Co.,Ltd.

The content of this document has been carefully checked and understood. However, neither Semiwell nor its subsidiaries assume any liability whatsoever for any errors or inaccuracies of this document and the consequences thereof. Published specifications are subject to change without notice. Product suitability for any area of application must ultimately be determined by the customer. In all cases, products must never be operated outside their published specifications. Semiwell does not guarantee the availability of all published products. This disclaimer shall be governed by substantive Chinese law and resulting disputes shall be settled by the courts at the place of business of Semiwell. Latest publications and a complete disclaimer can be downloaded from the Semiwell website. All trademarks recognized.