

FEATURES

- | Low power loss, high efficiency
- | Ideal for automated placement
- | Glass passivated junction chip
- | Fast switching for high efficiency

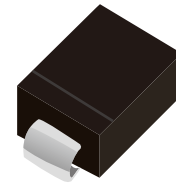

DO-214AA(SMB)

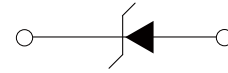

Schematic Symbol

APPLICATIONS

- | Switching mode power supply (SMPS)
- | Adapters
- | Lighting application
- | Converter

APPROVALS

RoHS	Compliance with 2011/65/EU
HF	Compliance with IEC61249-2-21:2003

MAXIMUM RATINGS AND CHARACTERISTICS (T_A=25°C)

Parameter	Symbol	RS2A	RS2B	RS2D	RS2G	RS2J	RS2K	RS2M	Unit
Marking		RS2A	RS2B	RS2D	RS2G	RS2J	RS2K	RS2M	
Repetitive peak reverse voltage	V _{RRM}	50	100	200	400	600	800	1000	
Reverse voltage, total rms value	V _{RMS}	35	70	140	280	420	560	700	V
Maximum DC blocking voltage	V _{DC}	50	100	200	400	600	800	1000	
Forward current	I _{F(AV)}	2							A
Surge peak forward current, 8.3ms single half sine-wave superimposed on rated load per diode	I _{FSM}	50							
Forward voltage per diode ⁽¹⁾ I _F =2A, T _J =25°C	V _F	1.3							V
Reverse current @ rated V _R per diode ⁽²⁾	I _R	5							uA
		50							
Reverse recovery time I _F =0.5A, I _R =1.0A, I _{RR} =0.25A	T _{rr}	150				250	500	ns	
Junction capacitance 1 MHz, V _R =4.0V	C _J	50							pF
Junction-to-lead thermal resistance per diode	R _{θJL}	18							°C/W
Junction-to-ambient thermal resistance per diode	R _{θJA}	55							°C/W
Operating junction and storage temperature range	T _J , T _{STG}	-55 to +150							°C

Note:
 1. Pulse test with PW=0.3 ms
 2. Pulse test with PW=30 ms

CHARACTERISTIC CURVES

Fig. 1- Forward Current Derating Curve

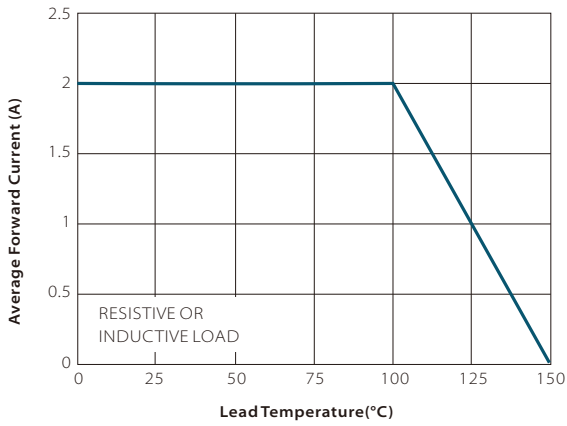

Fig. 2-Typical Reverse Characteristics

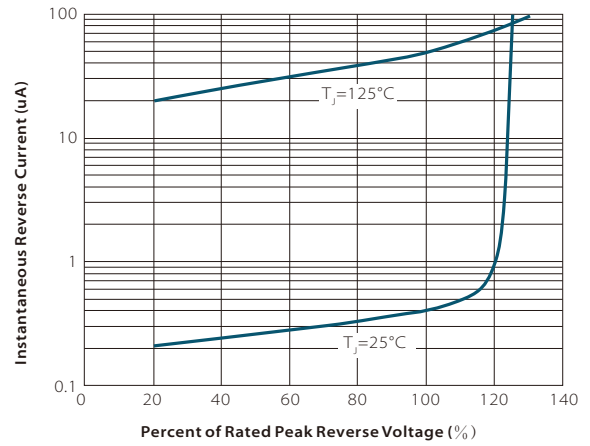

Fig. 3-Typical Junction Capacitance

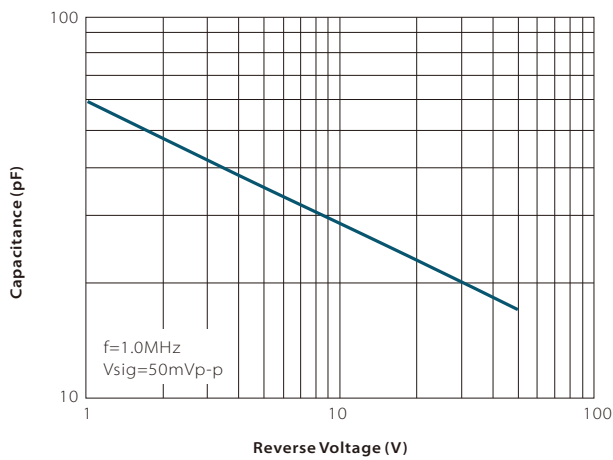

Fig. 4-Typical Forward Characteristics

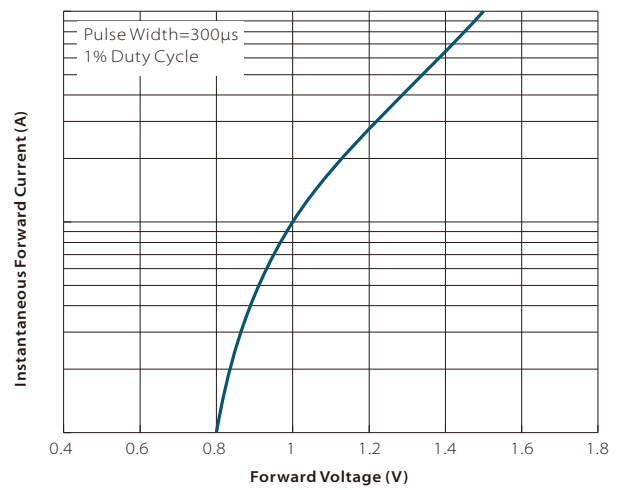

Fig. 5- Maximum Non-repetitive Forward Surge Current

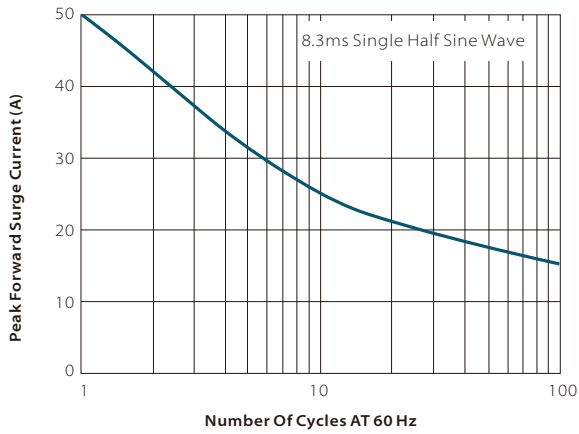
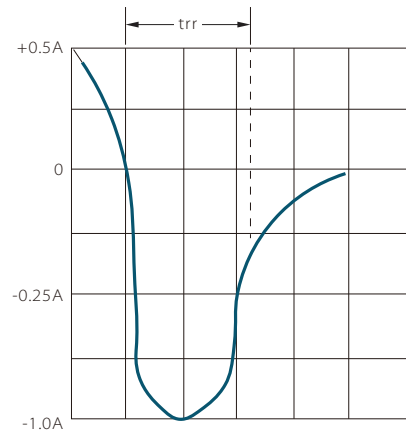
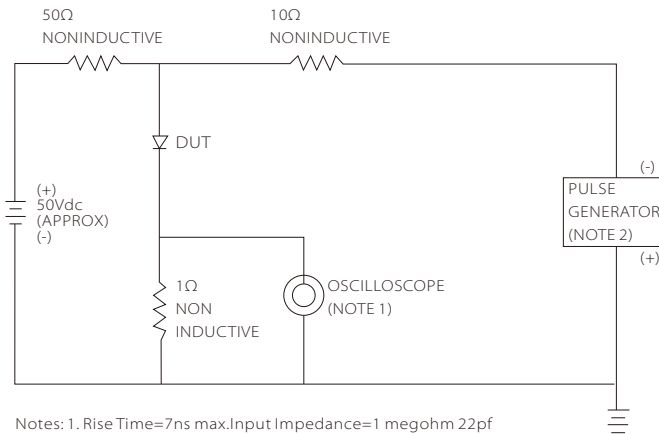
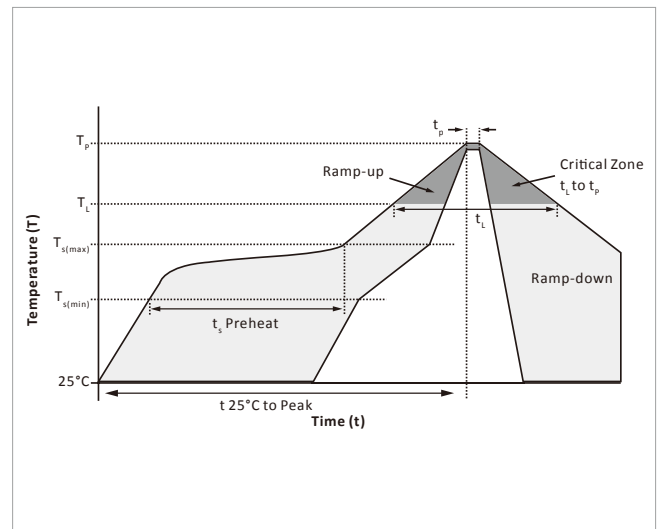

Fig. 6-Reverse Recovery Time Characteristic And Test Circuit Diagram



SOLDERING PARAMETERS

Reflow Condition		Lead-free assembly
Pre Heat	Temperature Max ($T_{s(min)}$)	150°C
	Temperature Max ($T_{s(max)}$)	200°C
	Time (min to max) (t_p)	60 – 180 secs
Average ramp up rate (Liquidus Temp (T_L) to peak)		3°C/second max
$T_{s(max)}$ to T_L - Ramp-up Rate		3°C/second max
Reflow	Temperature (T_L) (Liquidus)	217°C
	Time (min to max) (t_L)	60 – 150 seconds
Peak Temperature (T_p)		260°C
Time within 5°C of actual peak Temperature (t_p)		20 – 40 seconds
Ramp-down Rate		6°C/second max
Time 25°C to peak Temperature (T_p)		8 minutes max.
Do not exceed		260°C



DO-214AA(SMB) PACKAGE INFORMATION

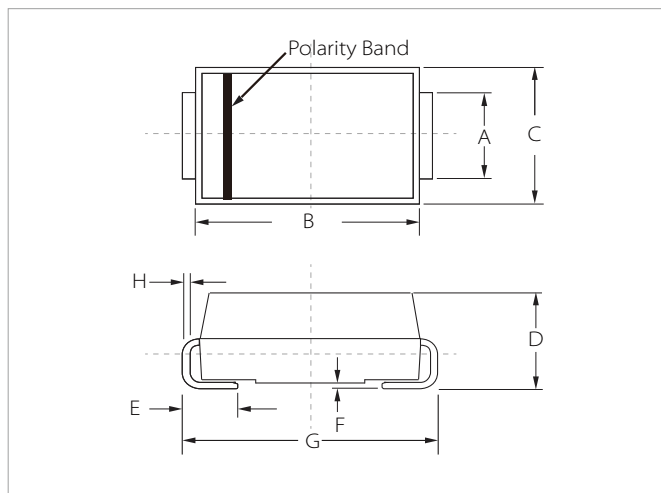

Ref.	Millimeters		Inches	
	Min.	Max.	Min.	Max.
A	1.80	2.20	0.071	0.087
B	4.30	4.70	0.170	0.185
C	3.40	3.90	0.134	0.153
D	2.15	2.55	0.085	0.100
E	1.00	1.50	0.039	0.059
F	0.02	0.20	0.001	0.008
G	5.10	5.50	0.200	0.216
H	0.15	0.30	0.006	0.012

RECOMMENDED PAD LAYOUT DIMENSIONS

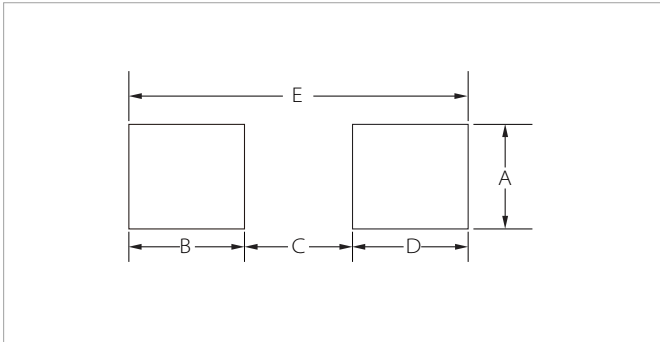

Ref.	Millimeters		Inches	
	Min.	Max.	Min.	Max.
A	2.20	-	0.087	-
B	1.45	-	0.057	-
C	-	2.55	-	0.010
D	1.45	-	0.057	-
E	5.60REF		0.220REF	

ORDERING INFORMATION

Part Number	Component Package	QTY/Reel	Reel Size
RS2A-RS2M	DO-214AA(SMB)	3000PCS	13"

To find your local partner within Semiwell's website : www.semiwell.com.cn

©2023 Semiwell Microelectronics Co.,Ltd.

The content of this document has been carefully checked and understood. However, neither Semiwell nor its subsidiaries assume any liability whatsoever for any errors or inaccuracies of this document and the consequences thereof. Published specifications are subject to change without notice. Product suitability for any area of application must ultimately be determined by the customer. In all cases, products must never be operated outside their published specifications. Semiwell does not guarantee the availability of all published products. This disclaimer shall be governed by substantive Chinese law and resulting disputes shall be settled by the courts at the place of business of Semiwell. Latest publications and a complete disclaimer can be downloaded from the Semiwell website. All trademarks recognized.